

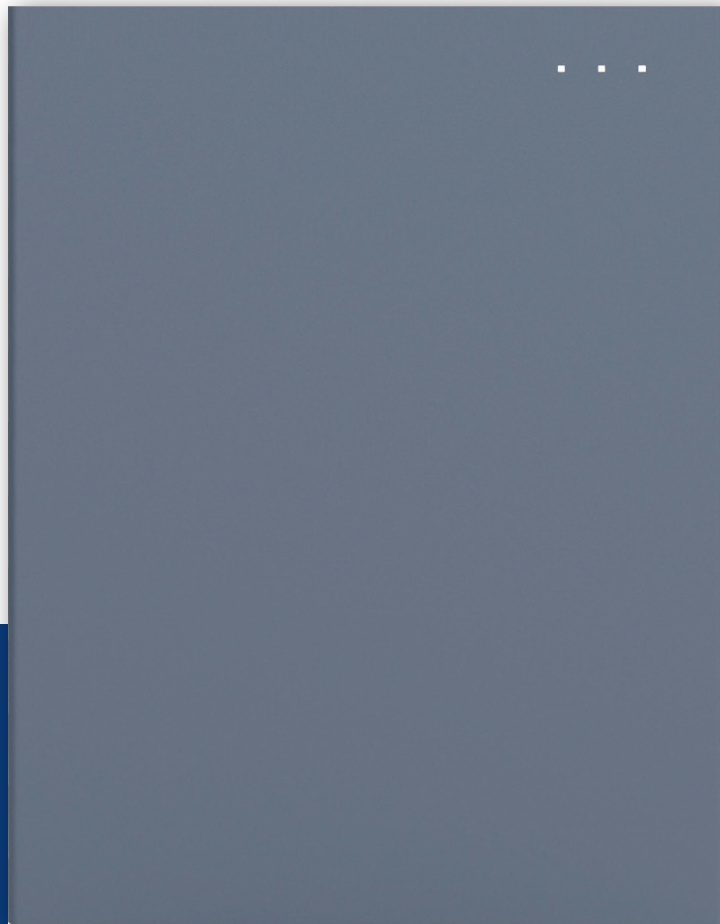

USER MANUAL

ES-BAT-10.1P



1. INTRODUCTION

1.1. Content and Structure of this Document

This document is valid for :

Battery: ES-BAT-10.1P

This document describes the mounting, installation, configuration, operation of the product as well as the operation of the product user interface.

Read this document through, understand the safety information, and get familiar with the functions and features of the device before installing and operating it.

Illustrations in this document are reduced to the essential information and may deviate from the real product.

You will find the latest version of this document and further information on the product in PDF format at www.eastmanworld.com



1.2. Target Group

This document is intended for qualified persons and end users. Only qualified persons are allowed to perform the operations marked with a warning symbol in this document. Tasks that do not require any specific qualifications will not be marked and can be performed by the end user. Qualified persons must have.

- Knowledge of working principle of inverters.
- Knowledge of how to deal with the dangers and risks associated with installing and using electrical devices, batteries and systems.
- Knowledge of the installation and commissioning of electrical devices and systems.
- Knowledge of the applicable standards and directives.
- Understood and complied with this document, including all safety precautions.
- Understood and complied with the documents of the battery manufacturer, including all safety precautions.

1.3. Levels of Warning Messages

The following levels of warning messages may occur when handling the product

 DANGER
<p>DANGER indicates a hazardous situation which, if not avoided, will result in death or serious injury.</p>
 WARNING
<p>WARNING indicates a hazardous situation which, if not avoided, could result in death or serious injury.</p>
 CAUTION
<p>CAUTION indicates a hazardous situation which, if not avoided, could result in minor or moderate injury.</p>
NOTICE
<p>NOTICE indicates a situation which, if not avoided, can result in property damage.</p>
<p>INFORMATION provides tips which are valuable for the optimal installation and operation of the product.</p>

2. safety

2.1 Intended Use

Battery pack is used for the energy storage, This system is suitable for indoor and outdoor installation.

All components must operate in a scenario suitable for their operation.

Be sure to use this product in accordance with the information provided in the accompanying documents and local applicable standards and directives. Any other operation may cause personal injury or property damage.

Alterations to the product, e.g. changes or modifications, are only permitted with the express written permission of Eastman. Unauthorized alterations will void guarantee and warranty claims. Eastman shall not be held liable for any damage caused by such changes.

Any use of the product other than that described in the Intended Use section does not qualify as appropriate.

The enclosed documentation is an integral part of this product. Keep the documentation in a convenient place for future reference and comply with all instructions contained therein.

The type label must remain permanently attached to the product.

2.1. Safety Instructions for Battery

2.1.1. General Safety Precautions

- Over voltage or wrong wiring can damage the battery pack and cause deflagration, which can be extremely dangerous.
- All types of breakdown of the battery may lead to a leakage of electrolyte or flammable gas.
- Battery pack is not user-serviceable. There is high voltage in the device.
- Read the label with Warning Symbols and Precautions, which is on the right side of the battery pack.
- Do not connect any AC conductors or PV conductors directly to the battery pack which should be only connected to the inverter.
- Do not charge or discharge damaged battery.
- Do not damage the battery pack in such ways as dropping, deforming, impacting, cutting or penetrating with a sharp object. It may cause a leakage of electrolyte or fire.
- Do not expose battery to open flame.

2.1.2. Response to Emergency Situations

The battery pack is composed of multiple batteries and designed to prevent the danger caused by malfunction.

- If the user touches the inner material of the battery cells due to damage to the shell, the following actions are recommended.
 1. Inhalation: Leave the contaminated area immediately and seek medical attention.
 2. Eye injuries: Rinse eyes with running water for 15 minutes and seek medical attention.
 3. Skin injuries: Wash the contacted area with soap thoroughly and seek medical attention.
 4. Ingestion: Induce vomiting and seek medical attention.

If a fire breaks out in the place where the battery pack is installed, perform the following countermeasures:

- Fire extinguishing media
 1. Respirator is not required during normal operations.
 2. Use FM-200 or CO² extinguisher for battery fire.
 3. Use an ABC fire extinguisher, if the fire is not from battery and not spread to it yet.

- Firefighting instructions

1. If fire occurs when charging batteries, if it is safe to do so, disconnect the battery pack circuit breaker to shut off the power to charge.
2. If the battery pack is not on fire yet, extinguish the fire before the battery pack catches fire.
3. If the battery pack is on fire, do not try to extinguish but evacuate people immediately.

 **WARNING**

There may be a possible explosion when batteries are heated above 150°C. When the battery pack is burning, it leaks poisonous gases. Do not approach.

- Effective ways to deal with accidents

1. On land: Place damaged battery into a segregated place and call local fire department or service engineer.
2. In water: Stay out of the water and don't touch anything if any part of the battery, inverter, or wiring is submerged.
3. Do not use submerged battery again and contact the service engineer.

2.2. Important Safety Instructions

 **DANGER**

Danger to life due to electric shock when live components or cables are touched.

There is high voltage in the conductive components or cables of the product. Touching live parts and cables can result in death or lethal injuries due to electric shock.

- Do not touch non-insulated parts or cables.
- Disconnect the product from voltage sources and make sure it cannot be reconnected before working on the inverter or the battery pack.
- After disconnection, wait for 5 minutes until the capacitors have discharged.
- Do not open the product.
- Wear suitable personal protective equipment for all operations on the product.

 **DANGER****Danger to life due to danger voltages on the battery pack.**

There is danger voltage at the pin connector for the power cable. Reaching into the pin connector for the power cable can result in lethal electric shock.

- Do not open the battery pack.
- Do not wipe over the battery pack with a damp cloth.
- Leave the protective caps on the pin connectors for the batteries power connection until the inverter cables are connected to the battery pack.
- Disconnect the system from voltage sources and make sure it cannot be reconnected before working on the inverter or the battery pack.

 **WARNING****Risk of chemical burns from electrolyte or toxic gases.**

During normal operation, no electrolyte would leak from the battery pack and no toxic gases would form. Despite careful construction, if the battery pack is damaged or a fault occurs, it is possible that electrolyte may be leaked or toxic gases may form.









- Store the battery pack in a cool and dry place.
- Do not drop the battery pack or damage it with sharp objects.
- Only set the battery pack down on its back or its bottom.
- Do not open the battery pack.
- Do not install or operate the battery pack in potentially explosive atmosphere or areas of high humidity.
- If moisture has penetrated the battery pack (e.g. due to a damaged housing), do not install or operate the battery pack.
- In case of contact with electrolyte, rinse the affected areas immediately with water and consult a doctor without delay.









NOTICE**Damage due to cleaning agents.**

- The use of cleaning agents may cause damage to the product and its components.
- Clean the product and all its components only with a cloth moistened with clear water.

- 
- Danger to life due to electric shock when touching live system components in case of a ground fault.
 - When a ground fault occurs, parts of the system may still be live. Touching live parts and cables can result in death or lethal injuries due to electric shock.
 - Disconnect the product from voltage sources and make sure it cannot be reconnected before working on the device.

2.3. Symbols explanation

Symbol	Explanation
	Beware of a danger zone This symbol indicates that the product must be additionally grounded if additional grounding or equipotential bonding is required at the installation site.
	Beware of electrical voltage The product operates at high voltages.
	Delayed discharge. Wait 5 minutes after power off until the components are completely discharged.
	WEEE designation Do not dispose of the product together with the household waste. Discard the product in compliance with the local laws and regulations, or send it back to the manufacturer.
	Observe the documentation
	CE marking
	Certified safety
	RCM (Regulatory Compliance Mark)
	UKCA marking

	RoHS labeling
	Risk of chemical burns
	Risk of explosion
	Risk of electrolyte leakage
	Refer to the instruction for operation
	Use eye protection
	Fire, naked light and smoking prohibited
	No nearing
	Recycling code
UN38.3	Marking for transport of dangerous goods The product passes the certifications of the UN38.3

3. Product Introduction and Application Scenarios

3.1. System introduction



Dimension(W×H×D): 590×750×205mm

Object	Name	Explain
1	ES-BAT-10.1P	Battery

3.1.1. Battery Introduction

Battery pack appearance and dimensions of ES-BAT-10.1P

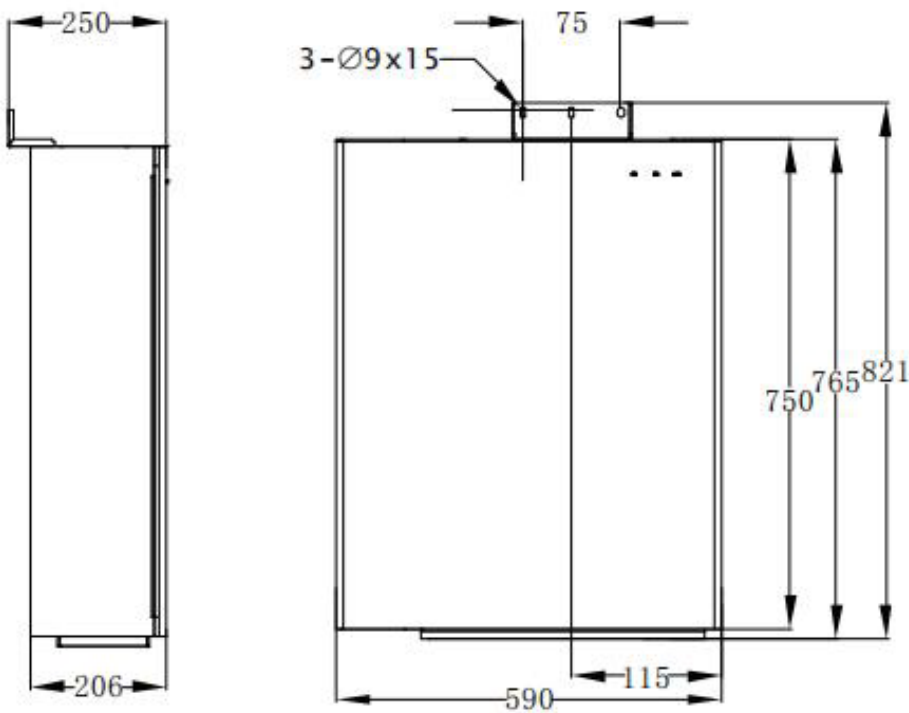

Connection area overview of ES-BAT-10.1P

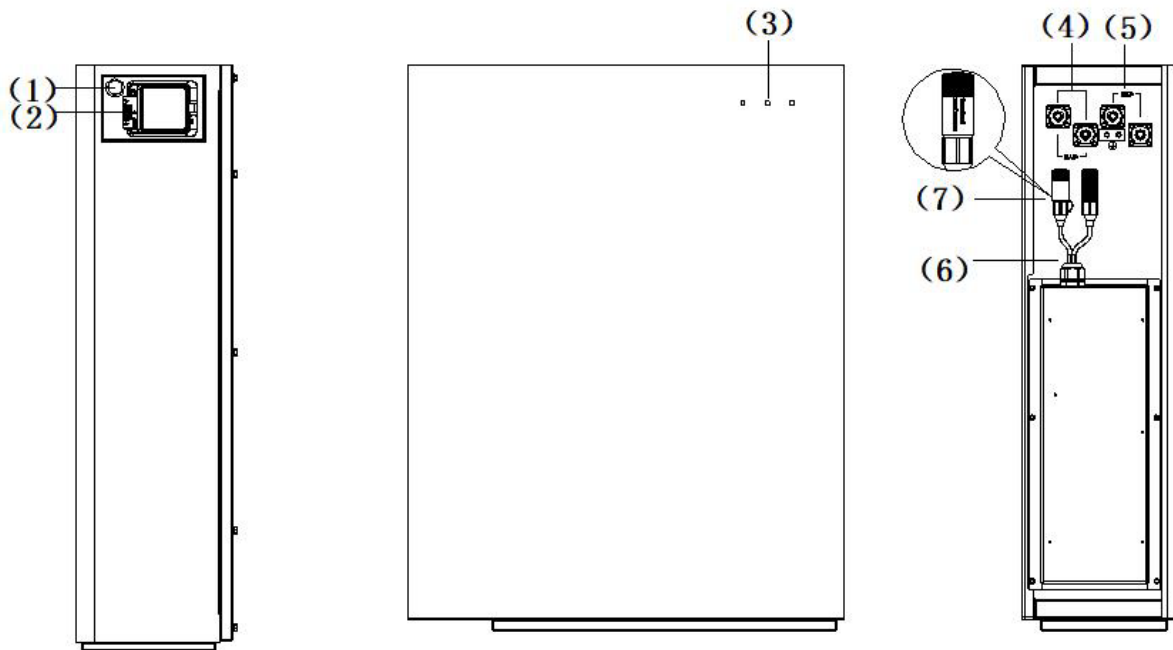

Position	Designation
1	Battery Power Button
2	Battery Breaker
3	Battery LED Display
4	Battery+ Power Connector
5	Battery- Power Connector
6	Grounding
7	BMS COM Ports: BMS COM 1, BMS COM 2 (with terminal resistance)



















The three LED indicators on the front cover provide information about the SOC operational status of this battery with lights displaying solid white or flashing.

3.1.2. LED DISPLAY

 : White LEDs flash

 : White LEDs on

 : White LEDs off













LED Indicator	No.	SOC	Description
LEDs show the SOC status	1	  	SOC≤10%
	2	  	10%<SOC≤30%
	3	  	30%<SOC≤50%
	4	  	50%<SOC≤60%
	5	  	60%<SOC≤90%
	6	  	90%<SOC≤100%













The three LED indicators on the front cover provide information about the protection status of the battery with lights displaying solid yellow or flashing.

 : Yellow LEDs flash



 : Yellow LEDs on

 : Yellow LEDs off

LED Indicator	Protection No.	LED Display	Description	Troubleshooting
Yellow LEDs on or Yellow LEDs flash once per second.	1	  	Temperature difference	Wait for automatic recovery. If the problem is not been solved yet, please call the service.
	2	  	High temperature	Stop discharging and charging until this display status is eliminated and wait for the temperature to drop.
	3	  	Low temperature discharge	Stop discharging until this display status is eliminated and wait for the temperature to rise
	4	  	Overcurrent charge	Wait for automatic recovery. If the problem is not be solved yet, please call the service.

	5	  	Overcurrent discharge	
	6	  	Cell overvoltage	
	7	  	Cell under voltage	Stop discharging and call the service immediately.
	8	  	Low temperature charge	Stop discharging until this display status is eliminated and wait for the temperature to rise.

NOTE:



























During work mode, if the protection status “Cell under voltage”    appears, please press the power button of the battery 5 times within 10 seconds, the BMS will be forced to turn on the MOSFET of discharge so that the inverter can detect the battery open voltage and charge the battery.



The three LED indicators on the front cover provide information about the error status of the battery with lights displaying solid yellow or flashing.

 : Yellow LEDs flash

 : Yellow LEDs on

 : Yellow LEDs off

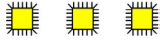
LED Indicator	Error No.	LED Display	Description	Troubleshooting
Yellow LEDs on or Yellow LEDs flash once per second	1	  	Hardware error	Wait for automatic recovery. If the problem is not been solved yet, please call the service.
	2	  	Hardware error	
	3	  	Circuit breaker open	Switch on the circuit breaker after powering off the battery.
	4	  	LMU disconnect (slave)	Reconnect the BMS communication cable.
	5	  	SN missing	Call for service.
	6	  	LMU disconnect (master)	Reconnect the BMS communication cable.
	7	  	Software version inconsistent	Call for service.
	8	  	Multi master	Restart all batteries.
	9	  	MOS overtemperature	Power off the battery and power on the battery after 30 minutes.

10		Insulation fault	Restart battery and in case the problem is not resolved, call for service.
11		Total voltage fault	Restart battery and in case the problem is not resolved, call for service.

4. Storage and Transport

4.1. Battery Storage

The following requirements should be met if the battery is not put into use directly:

1. Place batteries according to the signs on the packing case during storage. Do not put batteries upside down or sidelong.
2. Stack battery packing cases by complying with the stacking requirements on the external package.
3. Store the battery pack out of reach of children and animals.
4. Store the battery pack where it should be minimal dust and dirt in the area.
5. Handle batteries with caution to avoid damage.
6. The storage environment requirements are as follows:
 - a. Ambient temperature: $-10\sim 55^{\circ}\text{C}$, recommended storage temperature: $15\sim 30^{\circ}\text{C}$
 - b. Relative humidity: 15%~ 85%
 - c. Place batteries in a dry and clean place with proper ventilation.
 - d. Place batteries in a place that is away from corrosive organic solvents and gases.
 - e. Keep batteries away from direct sunlight.
 - f. Keep batteries at least 2 m away from heat sources.
7. The batteries in storage must be disconnected from external devices. The indicators (if any) on the batteries should be off.
8. Batteries should be delivered based on the "first in, first out" rule.
9. The warehouse keeper should collect battery storage information every month and periodically report the battery inventory information to the planning department. The batteries that have been stored for nearly 6 months should be recharged timely.
10. If a lithium battery is stored for a long time, capacity loss may occur. After a lithium battery is stored for 12 months in the recommended storage temperature, the irreversible capacity loss rate is 3%~10%. It is recommended that batteries not be stored for a long period. If the batteries need to be stored for more than 6 months, it is recommended to recharge the batteries to 65~75% of the SOC.

4.2. Transport

During transportation, please follow these guidelines:

1. Priority to use the original packaging for transportation. If the original packaging is not available, put the product inside a suitable cardboard box and seal it properly.
2. Handle with care, choose the corresponding handling method according to the weight, and pay attention to safety.
3. During transportation, please keep the packaging away from dangerous sources and take waterproof measures;
4. Please fix the packaging during transportation to prevent falling or mechanical impact;

5. Mounting







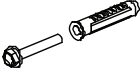

5.1. Checking the Outer Packing

Before unpacking the product, check the outer packing for damage, such as holes and cracks. If any damage is found, do not unpack the product and contact your dealer as soon as possible.

5.2. Scope of Delivery

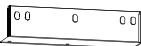
Check the scope of delivery for completeness and any externally visible damage. Contact your distributor if the scope of delivery is incomplete or damaged.

Accessory bag for Battery

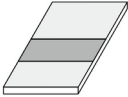
			
Battery Pack (X1)	Wall Anchor ST6*55 (X4)	Spanner (X1)	Ring Terminal (x4)
			
Y type terminal (x2)	Wall bracket (x1)	Screw M5*10 (X4)	Expansion Bat ± Power Cable (X1)
			
Battery Communication Cable (X1)	Quick Installation Guide (X1)		

5.3. Requirements for Mounting

 **WARNING**

Danger to life due to fire or explosion

Despite careful construction, electrical devices can cause fires.

- Do not mount the battery in areas containing highly flammable materials or gases.
- Do not mount the battery in potentially explosive atmospheres.

5.3.1. Basic Requirements

- The ES Battery is suitable for indoor and outdoor use.
- Do not mount the battery in areas with flammable or explosive materials.
- Do not mount the battery at a place within children's reach.
- Do not mount the battery outdoors in salt areas because it will be corroded there and may cause fire. A salt area refers to the region within 500m from the coast or prone to sea breeze. The regions prone to sea breeze vary depending on weather conditions (such as typhoons and monsoons) or terrains (such as dams and hills).

5.3.2. Mounting Environment Requirements

- The battery must be mounted in a well-ventilated environment to ensure good heat dissipation.
- When mounted under direct sunlight, battery may be derated due to additional temperature rise.
- Mount the battery in a sheltered place or mount an awning over the product.
- The optimal temperature range for the battery pack to operate is from 15 to 30°C.
- Do not expose or place near water sources like downspouts or sprinklers.
- If the battery pack is mounted in the garage, then ensure that it is above the height of the vehicle bumper and/ or door.

5.3.3. Mounting Structure Requirements

- The mounting structure where the battery is mounted must be fireproof.
- Do not mount the battery on flammable building materials.
- Ensure that the mounting surface is solid enough to bear the weight load.

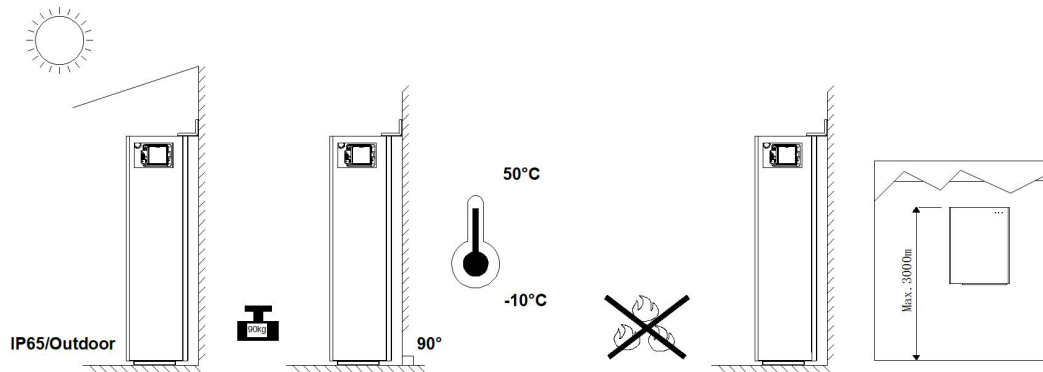

5.3.4. Mounting Angle and Stack Requirement

The battery should be mounted on the wall.

The installation angle requirement is as follow:

- Do not mount the battery at forward tilted, side tilted, horizontal, or upside down positions.

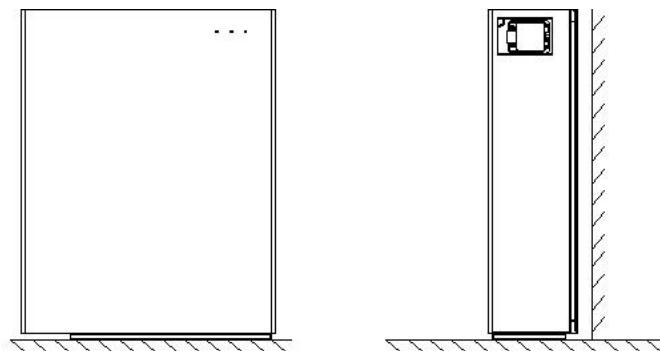

5.3.5. Mounting Space Requirements

- Reserve sufficient clearance around the product to ensure sufficient space for installation, maintenance and heat dissipation.
- The side clearance is a recommendation. Keep the clearance as short as you can if there is no influence to the operation and maintenance.



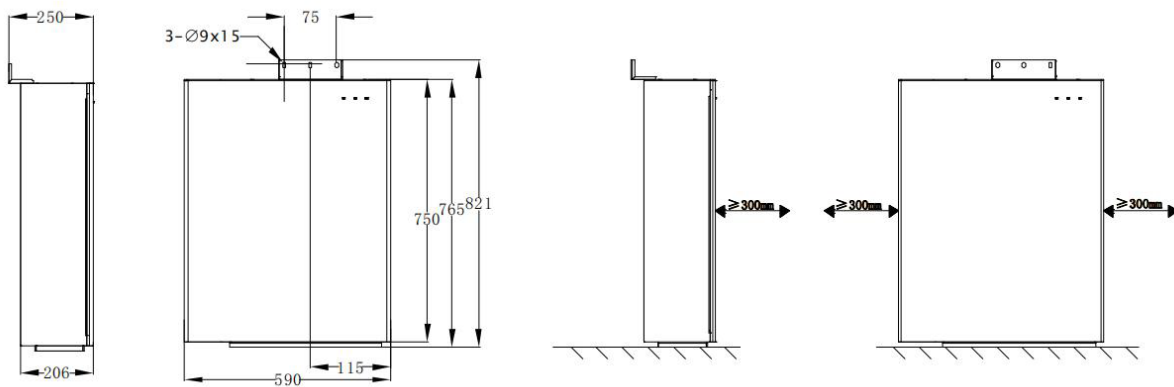











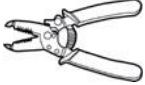



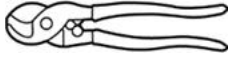

Recommended clearances

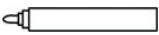

NOTICE

The space between the left and right batteries is recommended distance. Keep the distance as short as possible if there is no influence to the operation and maintenance.

5.4. Preparing Tools and Instruments

Category	Tools and Instruments		
Installation			
	Hammer drill (with a $\Phi 10$ mm drill bit)	Torque socket wrench SW10	Multimeter (DC voltage range ≥ 1000 V DC)
			
	Diagonal pliers	Wire stripper	T20 screwdriver (torque range: 0-5 N m) L < 200mm
			
	Rubber mallet	Utility knife	Cable cutter
			
	Crimping tool (model: PV-CZM-22100)	Cord end terminal crimper	Disassembly and Assembly Tool of PV connector
			
	Vacuum cleaner	Heat shrink tubing	Heat gun
			
Marker	Measuring tape	Bubble or digital level	
Personal Protective Equipment			
	Safety gloves	Safety goggles	Anti-dust respirator
			
Safety shoes			

5.5. Mounting the Product

5.5.1. Mounting the Battery

- a. Take out the battery from the carton, transport it to the installation site with a handcart which bearing capacity should be greater than 200kg, tied with bandage.
- b. Place the battery against the wall, mount the wall panels and then mark drill positions.
- c. Fix the bolt wall bracket on the box with 3pcs M5*10 screws;
- d. Select a set of symmetrical OB holes for tracing points, and remove the product after tracing points are completed;
- e. Drill 2 holes on the wall with a diameter of 10mm and a depth of about 70mm.
- f. After cleaning the dust and other objects from the two holes, place 2 wall anchors into the holes, then attach the battery wall bracket to the wall by using the SW10 hexagon sleeve. Please use a level to ensure that the wall bracket is horizontal.

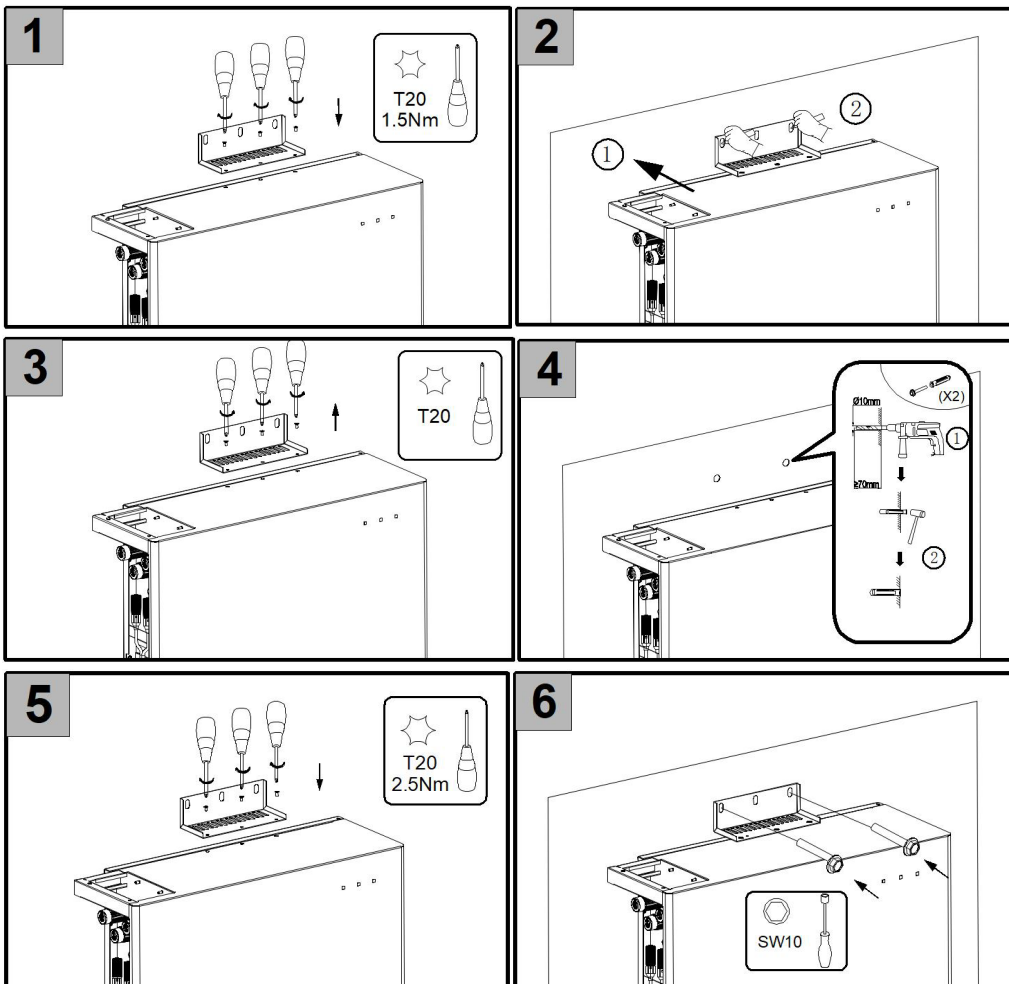

For mounting multiple batteries, please follow as above steps.

If you will install extra batteries by side, please keep the distance between two batteries greater than 300mm. You can install extra batteries up to 6 batteries in a system.

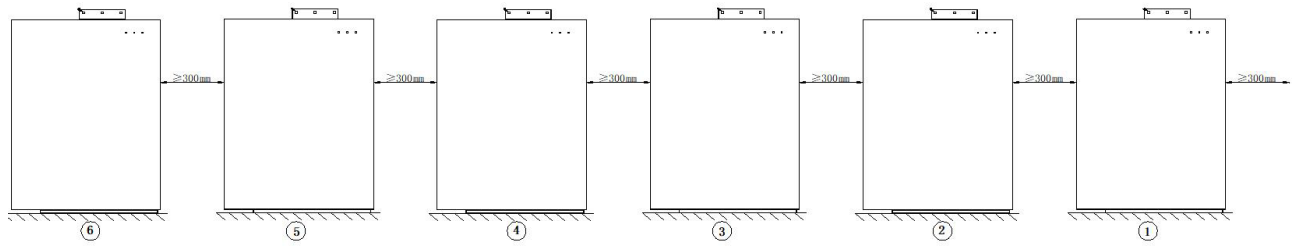

6. Electrical Connection

Precautions

DANGER

Before connecting cables, ensure that all breakers of the inverter and the battery packs and all the switches connected to inverters and the battery packs are set to OFF. Otherwise, the danger voltage of the energy storage system may result in electric shocks.

WARNING

- The energy storage system damage caused by incorrect cable connections is not covered under any warranty.
- Only certified electricians are allowed to connect cables.

Operation personnel must wear proper PPE when connecting cables

NOTICE

The cable colors shown in the electrical connection diagrams provided in this chapter are for reference only.

Select cables in accordance with local cable specifications (green-and-yellow cables are only used for PE).

6.1. Cable Requirements for Connection

No.	Cable	Type	Conductor Cross Section Area Range	Outer Diameter	Source
1	Battery power cable	Standard PV cable in the industry (recommended type: PV1-F)	16mm ²	N/A	Delivered with the battery
2	Battery communication cable	Standard network cable in the industry (recommended type: Cat5e, UTP, UV-resistant for outdoor use)	0.12 ~ 0.2 mm ² (AWG26~AWG24)	N/A	Delivered with the battery
3※1	Signal cable	Standard network cable in the industry (recommended type: Cat5e, FTP, UV-resistant for outdoor use)	0.12 ~ 0.2 mm ² (AWG26~AWG24)	4~6 mm	Purchased by the installer
4	PE cable	Single-core outdoor copper cable	6 ~ 10 mm ²	N/A	Purchased by the installer

※1 For CAN/RS485, LAN, Meter, DRM communication connection with inverter.

6.2. Connecting Additional Grounding

NOTICE

Electric Shock Hazard

Before doing electrical connection, please ensure the PV switch & all AC and BAT circuit breakers in the energy storage system are switched OFF and cannot be reactivated.

External grounding points are provided at the left side of the battery.

Prepare M5 OT terminals, strip the grounding cable insulation, insert the stripped part of the grounding cable into the ring terminal lug and crimp using a crimping tool.

Connect the OT terminal to grounding point using the torque 2.5 N.m with TX20 screwdriver.

Grounding connection on the battery.

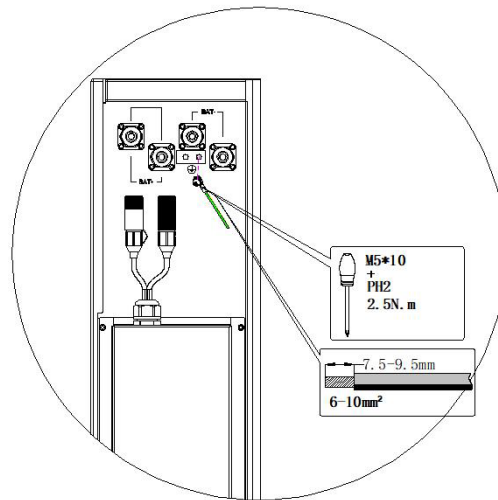

If you want to install more batteries, please perform grounding connection as follows.

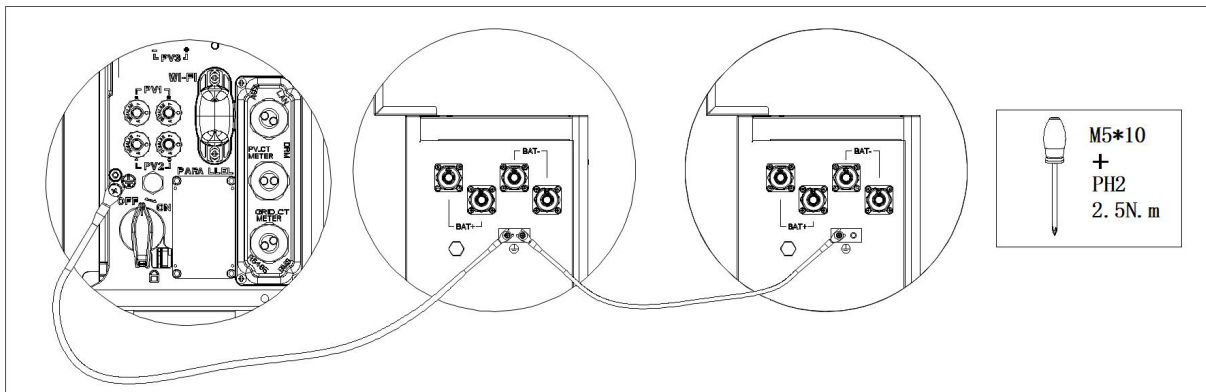

6.2.1. Electrical Connection Between the Inverter and Battery

Communication cable connection:

- a. Take out the battery communication cable from the battery package
- b. Lead the battery communication cable through the cable gland of the COM connection cover of inverter, don't tighten the swivel nuts of the cable glands, insert the RJ45 plugs to the BMS communication port.
- c. The battery communication ports of Battery series are at the top right of the battery, unscrew the 4 screws of the communication panel and remove it.
- d. Loosen the swivel nut of the cable gland on the battery communication panel, lead the battery communication cable through the cable gland, insert the RJ45 plugs to the BMS communication port of Battery series.
- e. Tighten the 4 screws of the communication panel, then tighten swivel nut of the cable gland.

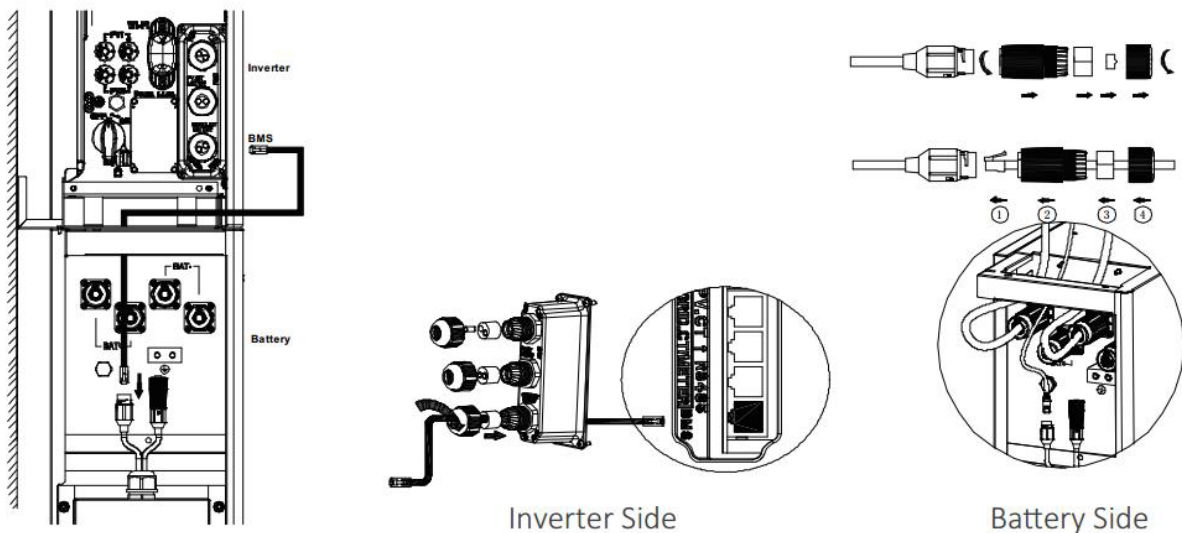

Power cable connection:

- a. Take out the battery power cables from the battery package.
- b. Remove the protective caps from the battery power connectors.
- c. Connect the battery power cables to the inverter and battery packs.
Please pay attention to the cable polarity, red cable is for battery positive.

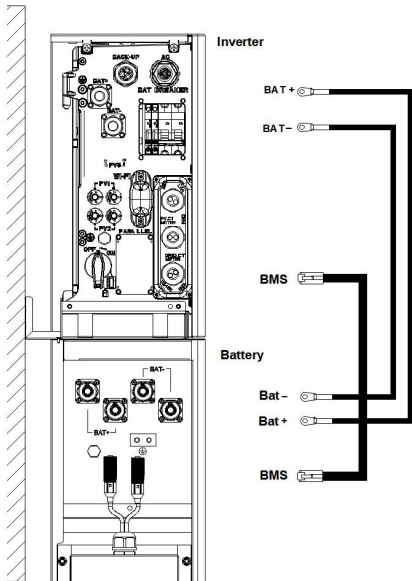
**DANGER****Danger to life due to short-circuiting of the battery**

Touching the short circuit connection of the battery results in death or lethal injuries due to electric shock and massive energy release.

Switch off the battery breaker which is located at the top right of the battery.

Please connect both ends of one battery power cable completely before connecting the next power cable to avoid short circuit of the positive and negative battery power cables.

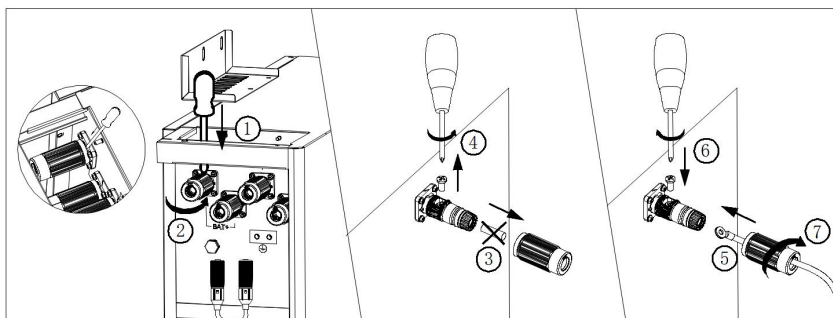
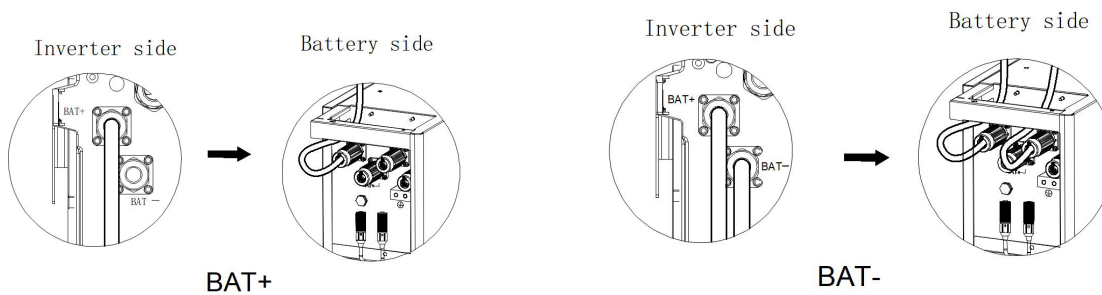
**DANGER****Danger to life due to short-circuiting of the battery**

Touching the short circuit connection of the battery results in death or lethal injuries due to electric shock and massive energy release.

- Switch off the battery breaker which is located on the right side of the battery.
- Please connect both ends of one battery power cable completely before connecting the next power cable to avoid short-circuiting of the positive and negative battery power cables.

6.2.2. Electrical Connection between Batteries

For electrical connection between multiple battery packs, please follow steps as chapter 6.5.1. Electrical Connection between the Inverter and First Battery.

For grounding connection between batteries, please refer to chapter 6.2. Grounding Connecting.

On one site, customer can install up to 6pc batteries in parallel with one hybrid inverter

Please install extra batteries by side, also batteries can be stacked up to two batteries per column.

NOTICE

Connect the cables between the batteries, route them from the rear side of the battery when two batteries mounting side by side.

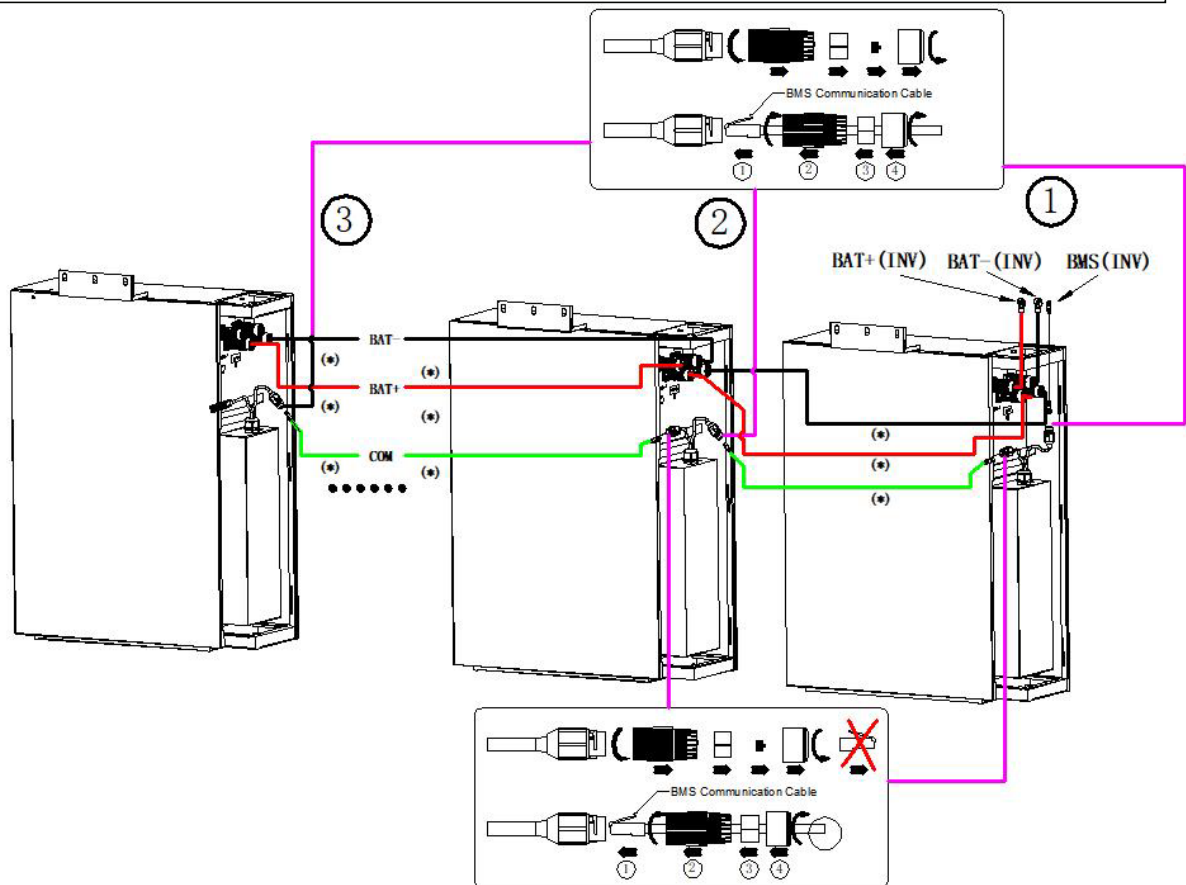

Accessory of cables with the (*) underneath are for battery expansion installation which need to be purchased additionally.

Powering On and Off the System

6.3. Powering on the System

- 1) Switch on the battery breaker of the batteries.
- 2) Switch on the DC breaker which is at the bottom of the inverter
- 3) Press the battery button, if there are more than one battery, the button for each battery should be pressed within 5s of the previous one.
- 4) Switch on the AC breaker between the grid port of the inverter and the grid.
- 5) Switch on the AC breaker between the backup port of the inverter and the loads.
- 6) Switch on the PV switch at the bottom of the inverter if there is any.
- 7) Switch on the AC breaker (if there is any) between the PV-inverter and the grid.

NOTICE

Eastman ES-BAT-10.1P battery series only matches with Eastman hybrid inverters ES-INV-SPH-3.6K AND ES-INV-SPH-5K
DC breaker: The Inverter DC breaker refers to the interface switch connecting the battery on the inverter

6.4. Powering off the System

WARNING

After the energy storage system is powered off, the remaining electricity and heat may still cause electric shocks and body burns. Therefore, put on protective gloves and operate the product 5 minutes after the power-off.

Procedure

- 1) Switch off the AC breaker between the inverter and the load.
- 2) Switch off the AC breaker between the inverter and the grid.
- 3) Switch off the PV switch at the bottom of the inverter if there is any.
- 4) Switch off the PV switch between the PV string and the inverter if there is any.
- 5) Switch off the DC breaker which is at the bottom of the inverter.
- 6) Long press 5s the power button of the battery.
- 7) Switch off the battery breaker of the battery.

7. COMMISSIONING

7.1. Checking Before Power-On

No.	Check Item	Acceptance Criteria
1	Mounting environment	The mounting space is proper, and the mounting environment is clean and tidy, without foreign objects.
2	Battery pack and inverter mounting	The battery pack and inverter are mounted correctly, securely, and reliably.
3	Cable layout	Cables are routed properly as required by the customer.
4	Cable tie	Cable ties are secured evenly and no burr exists.
5	Grounding	The ground cable is connected correctly, securely, and reliably.
6	Switch and breakers status	Battery breakers and all the breakers connecting to the product are OFF.
7	Cable connections	Battery power cables, and communication cables are connected correctly, securely, and reliably.
8	Unused power terminals	Unused power ports and communication ports are blocked by watertight caps.

7.2. Commissioning

Switch On:

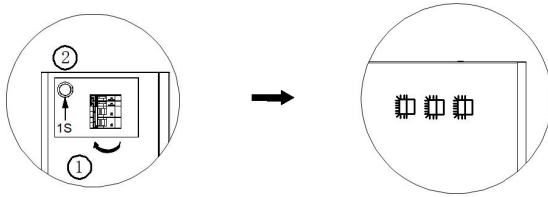

Switch Off:

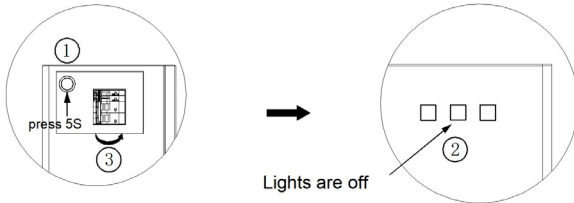

Battery Status	LEDs Display
Standby	Three white lights flash once a second.
Abnormal	The yellow lights are always on or flashing.

7.3. Mounting the Cable Cover

After finishing electrical connection of energy storage system, do the following operations.

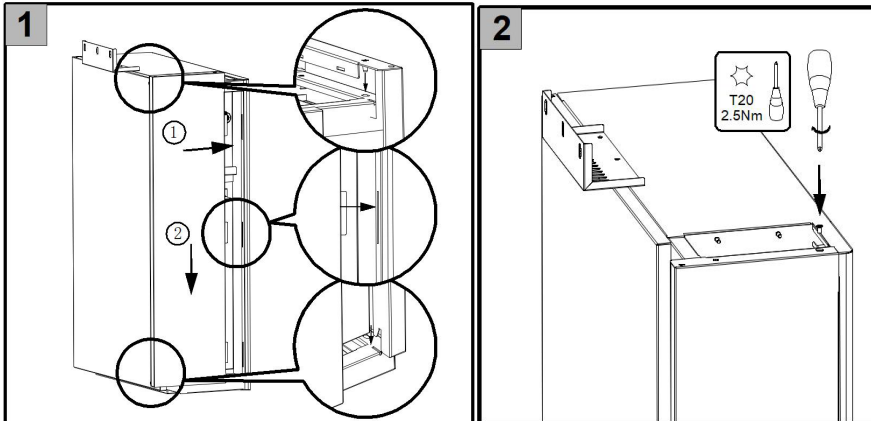

The following steps are only for battery expansion installation

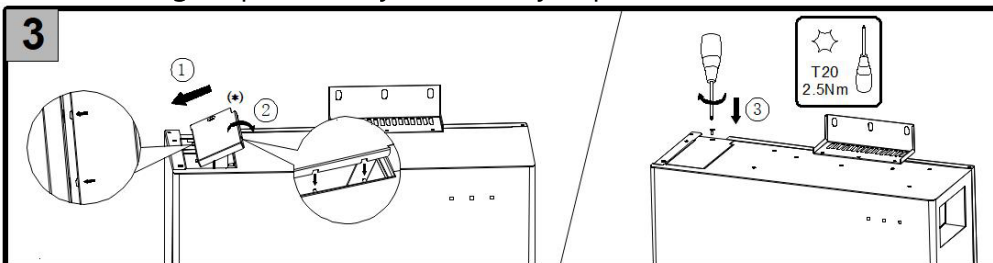

Little cover kit with the (*) beside is included in the battery expansion accessory which need to be purchased additionally.

8. Maintenance and Troubleshooting

8.1. Routine Maintenance

Normally, the energy storage system need no maintenance or calibration.

However, in order to maintain the accuracy of the SOC, it is recommended to perform a full charge calibration for SOC (charging battery until the charging power is 0) on the battery at regular intervals (such as two weeks).

Disconnect the system from all power sources before cleaning. Clean the housing, cover and display with a soft cloth.

To ensure that the energy storage system can operate properly in the long term, you are advised to perform routine maintenance on it as described in this chapter.

Maintenance checklist

Check Item	Acceptance Criteria	Maintenance Interval
Product cleanliness	The heatsink at the back of the product are free from obstacles or dust.	Once every 6 to 12 months
Product visible damage	The product are not damaged or deformed.	Once every 6 months
Product running status	<ol style="list-style-type: none"> 1. The product operate with no abnormal sound. 2. All parameters of the product are correctly set. Perform this check when the product is running. 	Once every 6 months
Electrical connections	<ol style="list-style-type: none"> 1. Cables are securely connected. 2. Cables are intact, and in particular, the cable jackets touching the metallic surface are not scratched. 3. Unused cable glands are blocked by rubber sealing which are secured by pressure caps. 	<p>Perform the first maintenance 6 months after the initial commissioning.</p> <p>From then on, perform the maintenance once every 6 to 12 months.</p>

 **CAUTION**
Risk of burns due to hot heatsink and housing

The heatsink and housing of the inverter can get hot during operation.

- During operation, do not touch any parts other than the cover.
- Wait approx. 30 minutes before cleaning until the heatsink has cooled down.

8.2. Troubleshooting**8.2.1. Battery Protection Description**

LED Indicator	Error Code	LED Display	Description	Troubleshooting
Yellow LEDs on or Yellow LEDs flash once per second.	1		Temperature difference	Wait for automatic recovery. If the problem is not solved yet, please call the service center.
	3		High-Temperature	Stop discharging and charging until this code is eliminated and wait for the temperature to drop.
	4		Low-temperature discharge	Stop discharging until this code is eliminated and wait for the temperature to rise
	5		Over-current charge	Wait for automatic recovery. If the problem is not solved yet, please call the service center.
	6		Over-current discharge	
	8		Cell overvoltage	
	9		Cell undervoltage	Stop discharging and call the service immediately.
	11		Low-temperature charge	Stop discharging until this code is eliminated and wait for the temperature to rise.

**NOTE**

In the case of work mode, if the protection code 9 appears, please press the power

button of the battery 5 times within 10 seconds, the BMS will be forced to turn on the MOSFET of discharge so that the inverter can detect the battery open voltage and charge the battery.

8.2.2. Battery Error Description

LED Indicator	Error Code	LED Display	Description	Troubleshooting
Yellow LEDs on or Yellow LEDs flash once per second.	Error 01		Hardware error	Wait for automatic recovery. If the problem is not solved yet, please call the service center.
	Error 05		Hardware error	
	Error 06		Circuit breaker open	Switch on circuit breaker after powering off the battery.
	Error 08		LMU disconnect (slave)	Reconnect the BMS communication cable.
	Error 09		SN missing	Call for service.
	Error 10		LMU Disconnect (master)	Reconnect the BMS communication cable.
	Error 11		Software version inconsistent	Call for service.
	Error 12		Multi master	Restart all batteries.
	Error 13		MOS over temperature	Power off the battery and power on the battery after 30 minutes.
	Error 14		Insulation fault	Restart battery and in case the problem is not resolved, call for service.
	Error 15		Total voltage fault	Restart battery and in case the problem is not resolved, call for service.

 **NOTE**

In the case of work mode, if the protection code 09 appears, please press the power button 5 times within 10 seconds, the BMS will be forced to turn on the MOSFET of discharge so that the inverter can detect the battery open voltage and charge the battery.

9. Uninstallation & Return

9.1. Removing the Product

Procedure

- Step 1: Power off the energy storage system by following instructions in Chapter 8.2 Powering Off the System.
- Step 2: Disconnect all cables from the product, including communication cables, PV power cables, battery power cables, AC cables, and PE cables.
- Step 3: Remove the WiFi module.
- Step 4: Remove the product from the wall bracket. Remove the expansion battery from the wall bracket.
- Step 5: Remove the wall brackets.

9.2. Packing the Product

If the original packaging is available, put the product inside it and then seal it using adhesive tape.

If the original packaging is not available, put the product inside a suitable cardboard box and seal it properly.

9.3. Disposing of the Product

- If the product service life expires, dispose of it according to the local disposal rules for electrical equipment and electronic component waste.
- Dispose of the packaging and replaced parts according to the rules at the installation site where the device is installed.
- Do not dispose the product with normal domestic waste.



10. Specification

Datesheet of Battery

Model	ES-BAT-10.1P
Battery type	LFP (LiFePO4)
Weight	90kg*
Dimension (W*D*H)	590*205*750mm*
Ingress protection	IP65
DoD	95%
Nominal voltage	96 V
Operating voltage range	90 ~ 108 V
Max. Charging /discharging current *	52.5 A
Operating temperature range	Charge: $0 < T < 50^{\circ}\text{C}$ / Discharge: $-10 < T < 50^{\circ}\text{C}^{**}$
Humidity	0~95%
Modules Connection	1 ~ 6 in parallel
Energy Capacity	10.1kWh
Usable Capacity	9.6kWh
Rated Power (kW)	5.04
Monitoring parameters	System voltage, current, cell voltage, cell temperature, PCBA temperature
BMS communication	CAN
Safety	IEC 62619:2017, IEC 62040:2017

Transportation	UN38.3
-----------------------	--------

* The weight and dimension is only for single module. The weight will be multiplied with the number of batteries. The depth and height are the same for all battery systems. But at least 300mm clearance is necessary between each module for all battery systems.

** When the temperature is below 0 °C or above 40 °C, the performance will be limited.



AMPS MIDDLE EAST FZ LLC
#703, 7TH Floor, Deira Twin Tower,
Baniyas Square, Deira, Dubai (UAE)

EASTMAN AUTO & POWER LTD.
ASF Towers, 249, Udyog Vihar Phase-4,
Gurugram, Haryana-122016, India

GUANGDONG EASTMAN NEW ENERGY CO., LTD
#1602, Meilan business centre, Intersection of Xixiang Avenue
and Qianjin Second Road, Bao'an, District, Shenzhen-518102, China