

User Manual

EM-5548 S1-ECO SOLAR INVERTER

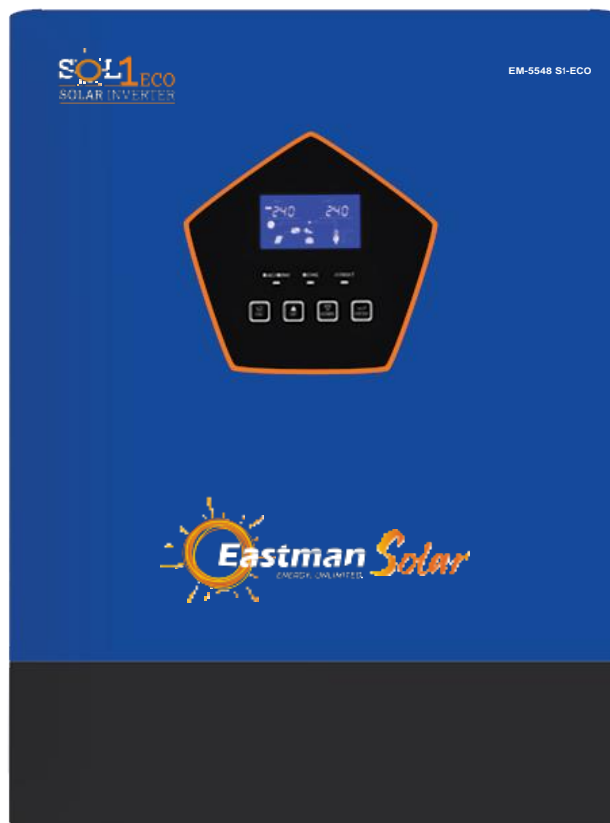

Table Of Contents

1. ABOUT THIS MANUAL	1
1.1 Purpose	1
1.2 Scope	1
1.3 Safety Instructions	1
2. INTRODUCTION.....	1
2.1 Features	2
2.2 Basic System Architecture	2
2.3 Product Overview	3
3. WIFI Connection(Optional).....	3
4. INSTALLATION	4
4.1 Unpacking and Inspection.....	4
4.2 Preparation	4
4.3 Mounting The Unit	4
4.4 Battery Connection	5
4.5 AC Input/Output Connection	6
4.6 PV Connection.....	7
4.7 Final Assembly	8
4.8 Dry Contact Signal.....	9
4.9 RS232 Communication Connection	9
4.10 Bluetooth Communication (Optional)	10
5. OPERATION	11
5.1 Power ON/OFF	11
5.2 Operation and Display Panel	11
5.3 LCD Display Icons	12
5.4 LCD Setting	14
5.5 Fault Reference Code.....	21
5.6 Battery Equalization Description	22
5.7 Warning Indicator.....	23
6.TROUBLE SHOOTING	24
7. SPECIFICATIONS	26
Table 1 Solar Mode Specifications	26
Table 2 Line Mode Specifications	27
Table 3 Charge Mode Specifications.....	28
Table 4 Inverter Mode Specifications	29
8.Installation Dimension Drawing.....	30

1. ABOUT THIS MANUAL

1.1 Purpose

This manual describes how to assemble, install and operate the units and how to troubleshoot of this unit. Please read this manual carefully before installation and operation. Keep this manual for future reference.

1.2 Scope

This manual provides guidelines of safety installation as well as the information on tools and wiring.

1.3 Safety Instructions

WARNING: This chapter contains important safety and operating instructions. Read and keep this manual for future reference.

1. Read and follow all installation, operation, and maintenance information carefully before using the product.

2. **CAUTION:** To reduce risk of injury, charge only deep-cycle lead acid type rechargeable batteries. Other types of batteries may burst, causing personal injury and damage.

3. Do not disassemble the unit personally. Take it to a qualified service center to repair.

4. To reduce risk of electric shock, disconnect all wiring before attempting any maintenance or cleaning, turning off the unit will not reduce this risk.

5. **WARNING :** Disconnecting all power supply before any maintaining or cleaning, please noted that if you only turn off the unit are not safe enough.

6. **WARNING:** Only qualified service persons are allowed to operate this product. If fault not solved after following troubleshooting table, please send this inverter back to local dealer or service center for maintenance.

7. **WARNING:** Because this inverter is non-isolated, only three types of PV modules are adaptable: single crystalline, poly crystalline with class A-rated and CIGS modules. To avoid any malfunction, do not connect any PV modules which likely with current leakage flow to the inverter. For example, grounded PV modules may cause current leakage flow to the inverter. When using CIGS modules, please be sure of NO grounding.

8. **CAUTION:** It's requested to use PV junction box with surge protection. Otherwise, it may cause damage on inverter.

2. INTRODUCTION

This is a multi-function inverter/charger; combining various functions of inverter, solar charger and battery charger. Supply uninterruptible electric energy to loads. It's comprehensive LCD display allowed user setting the various data according to user's requirements, such as battery charging current, AC/solar charger priority, and setting different input voltage based on different applications.

2.1 Features

1. Off grid inverter
2. Output power factor $\text{COS } \phi = 1.0$
3. Configurable AC/Solar Charger priority via LCD setting
4. Smart battery charger design for optimized battery performance
5. Compatible to mains voltage or generator power
6. Overload ,Over temperature ,Short circuit protection , battery low voltage
7. External WIFI devices
- 8.Can connect Bluetooth device

2.2 Basic System Architecture

The following illustration shows basic application for this inverter/charger. It also includes following devices to have a complete running system:

Generator or Utility. PV modules

Consult with integrators who provide you the system about the architectures as you request. This inverter can supply power to all kinds of appliances in home or office ,including motor-type appliances, such as tube light, fan, refrigerator and air-conditioner.

NOTE: The following picture is only a schematic diagram of the equipment .If the actual chassis does not conform to the schematic due to a structural upgrade, it is subject to prior notice.



Figure 1 Hybrid Power System

2.3 Product Overview

NOTE: The following picture is only a schematic diagram of the equipment .If the actual chassis does not conform to the schematic due to a structural upgrade, it is subject to prior notice.

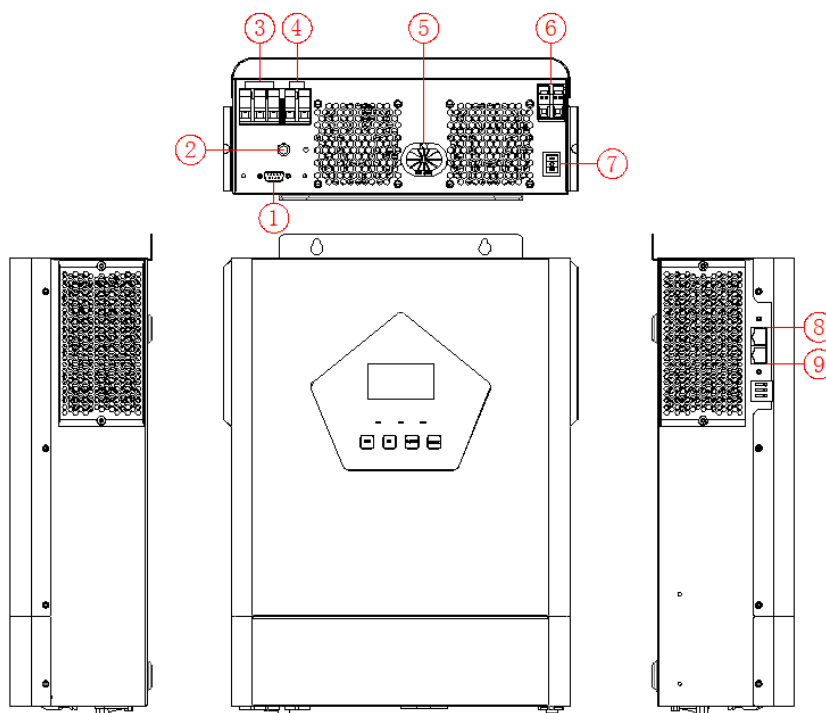
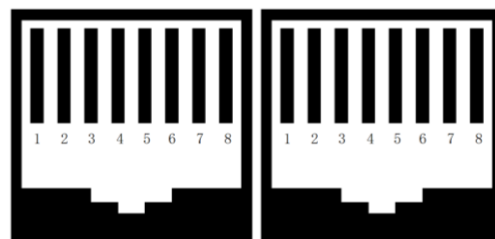

Figure 2:3.5K/5.5K model

- 1: WIFI port
- 2: Breaker
- 3: AC input
- 4: AC output
- 5: Battery input
- 6: PV input
- 7: Power on/off switch
- 8: RS232 Communication Port
- 9: BMS Communication Port

Communication port definition :

COMM: RS232	1:RXD, 2:TXD , 8:GND
BMS: RS485 CAN	1:485-B , 2: 485-A, 4: CAN-H , 5: CAN-L ,



COMM

BMS

3. WIFI Connection(Optional)

- 1.Users can download "SmartEss" WIFI monitoring software from the app store on their phone.
- 2.Inverters come equipped with factory-integrated Wi-Fi capability which makes it very easy to integrate into a home network (Wi-Fi Dongle is Optional)This makes it ideal for local monitoring via the inverter's own wireless home network or for online monitoring platforms.

4. INSTALLATION

4.1 Unpacking and Inspection

Before installation, please inspect the unit. Be sure that everything in the package is not damaged. The following items inside of package would be received.

The inverter x1
User manual x 1

4.2 Preparation

Please remove the two screws on the bottom cover of the inverter as shown below before connecting all wirings.

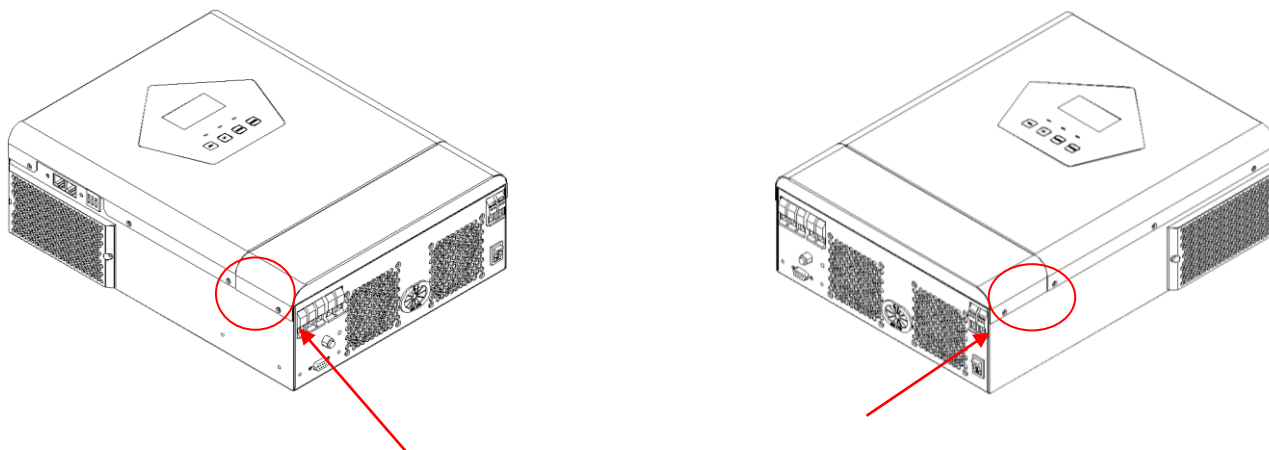

4.3 Mounting The Unit

Consider the followings before selecting your placements:

1. Do not mount the inverter on flammable construction
2. Mount on solid surface
3. Install the inverter at eye level in order to allow easy LCD display readout.
4. For proper air circulation and heat dissipation, allow a clearance of approx. 20 cm to the side and approx. 50 cm above and below the unit.
5. The ambient temperature should be between -10°C And 50°C to ensure optimal operation.
6. The recommended orientation is to adhered to the wall vertically.

Be sure to keep other objects and surfaces as shown in the diagram to guarantee sufficient heat dissipation and to have enough space for wiring.

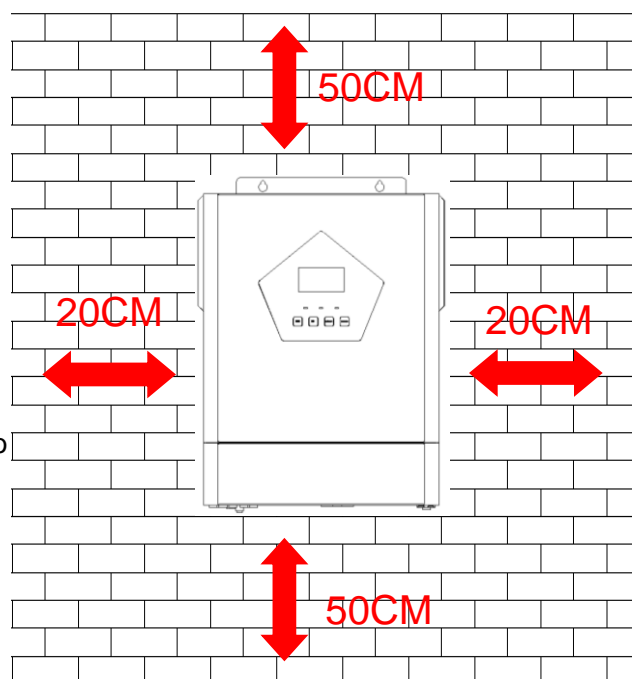

Note: Suitable for mounting on concrete or other non-combustible surface only

Install the unit by screwing two screws. It's recommended to use M4 or M5 screws.

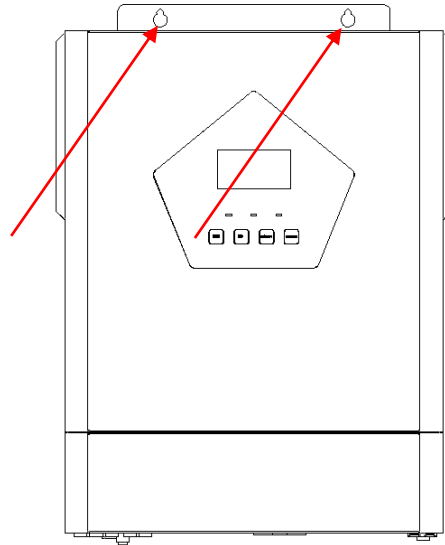

4.4 Battery Connection

CAUTION: For safety operation and regulation compliance, it's requested to adopt a separate DC over-current protector or disconnect device between battery and inverter. It may not be necessary to have a disconnect device in some applications, however, it's still need to adopt over-current protection device. Please refer to typical amperage in below table as required fuse or breaker size.

WARNING! All wiring must be performed by a qualified personnel.

WARNING! It's very important for system safety and efficient operation to use appropriate cable for battery connection. To reduce risk of injury, please use the proper cable as below.

Model	Typical amperage	Battery capacity	Gauge	Cable(mm ²)
3.5KW24Vdc	160A	200AH	1*2AWG	1*50
5.5KW48Vdc	125A	200AH	1*3AWG	1*35

24VDC battery connection diagram

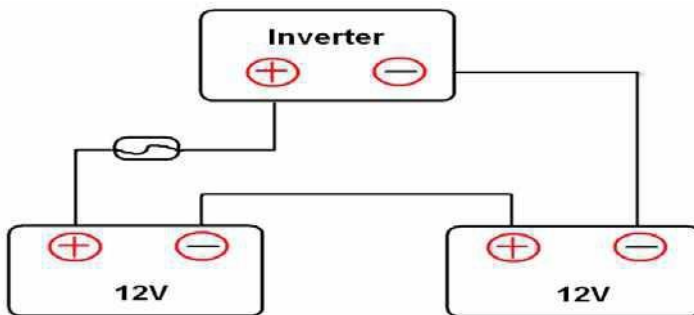

48VDC battery connection diagram

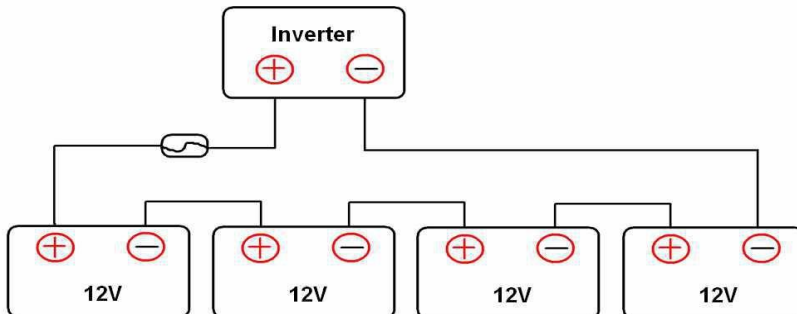

2. Prepare two battery wires for 3.5KW model and 5.5KW model depending on cable size (refer to recommended cable size table). Apply Tube type terminals to your battery wires and secure it to

the battery terminal block with the bolts properly tightened. Refer to battery cable size for torque value. Make sure polarity at both the battery and the inverter is correctly connected and ring terminals are secured to the battery terminals.

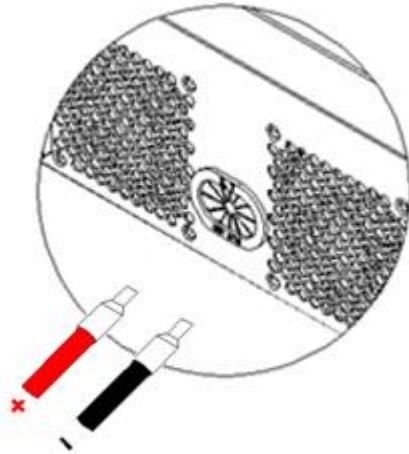

WARNING: Shock Hazard

Installation must be performed with care due to high battery voltage in series.

CAUTION!! Do not place anything between the flat part of the inverter terminal and the Tube type terminal. Otherwise, overheating may occur.

CAUTION!! Do not apply anti-oxidant substance on the terminals before terminals are connected tightly.

CAUTION!! Before connection the DC breaker, be sure positive (+) must be connected to positive (+) and negative (-) must be connected to negative (-).

4.5 AC Input/Output Connection

CAUTION! Before connecting to AC input power source, please install a separate AC breaker and lightning arrester between inverter and AC input power source. This will ensure the inverter can be securely disconnected during maintenance and fully protected from over current of AC input. The recommended spec of AC breaker is 32A for 3.5KVA and 50A for 5.5KVA. There are two terminal blocks with “IN” and “OUT” markings. Please do NOT connect input and output connectors wrong.

WARNING! All wiring must be performed by a qualified personnel. It's very important for system safety and efficient operation to use appropriate cable for AC input connection. To reduce risk of injury, please use the proper recommended cable size as below.

Model	Gauge	Cable (mm ²)	Torque Value(Max.)
3.5KW/5.5KW	10 AWG	6	1.4-1.6 Nm

4.6 PV Connection

CAUTION: It is forbidden for inverter to share the same solar panel group.

CAUTION: Before connecting to PV modules, please install separately a DC circuit breaker and lightning arrester between inverter and PV modules.

WARNING: It's very important for system safety and efficient operation to use appropriate cable for PV module connection .To reduce risk of injury ,please use the proper cable size as below.

Model	Wire Size	Cable (mm ²)	Torque value(max.)
3.5KW/5.5KW	12AWG	4	1.2-1.4 Nm

WARNING: Because this inverter is non-isolated, only three types of PV modules are acceptable : single-crystalline, poly crystalline with class A-rated and CIGS modules .To avoid any malfunction, do not connect any PV modules with possible current leakage to the inverter. For example, grounded PV modules will cause current leakage to the inverter. When using CIGS modules, please be sure NO grounding.

CAUTION: It's requested to use PV junction box with surge protection. Otherwise, it will cause damage on inverter when lightning occurs on PV modules.

PV Module Selection:

When selecting proper PV modules, please be sure to consider below parameters:

Open circuit Voltage (Voc) of PV modules not exceeds max. PV array open circuit voltage of inverter.

INVERTER MODEL	3.5KW/5.5KW
Max. PV Array Open Circuit Voltage	500Vdc
PV Array MPPT Voltage Range	60Vdc~450Vdc

Application Example:

Solar Panel Spec. 250Wp Vmp: 30.1Vdc Imp: 8.3A Voc: 37.7Vdc Isc: 8.4A	SOLAR INPUT	Q'ty of panels	Total input power
	(Min. in serial: 5 pcs, max. in serial: 11 pcs)		
	5 pcs in serial	5 pcs	1250W
	8 pcs in serial	8 pcs	2000W
	10 pcs in serial	10 pcs	2500W
	9 pieces in serial and 2 sets in parallel	18 pcs	4500W
	10 pieces in serial and 2 sets in parallel	20 pcs	5000W
	11 pieces in serial and 2 sets in parallel	22 pcs	5500W

Application Example 2:

Solar Panel Spec. 550Wp Vmp: 41.96Vdc Imp: 13.11A Voc:49.9Vdc Isc:14A	SOLAR INPUT	Q'ty of panels	Total input power
	(Min. in serial: 2 pcs, max. in serial: 9 pcs)		
	2pcs in serial	2 pcs	1100W
	4pcs in serial	4 pcs	1650W
	6pcs in serial	6 pcs	3300W
	8pcs in serial	8 pcs	4400W
	5 pieces in serial and 2 sets in parallel	10 pcs	5500W

PV Module Wire Connection

Please follow below steps to implement PV module connection:

1. Remove insulation sleeve 10 mm for positive and negative conductors.
2. Suggest to put bootlace ferrules on the end of positive and negative wires with a proper crimping tool.
3. Fix PV wire cover to the inverter with supplied screws as shown in below chart.

3. Check polarities of wire connections from PV modules to PV input screw terminals. Connect your wires as illustrated below.

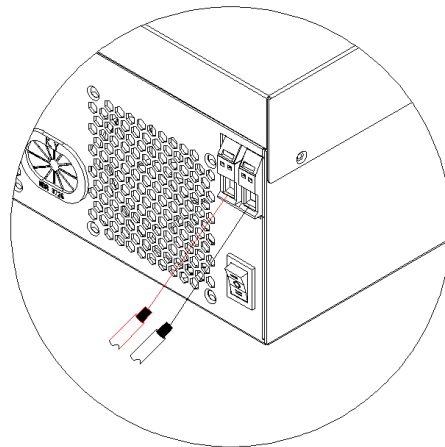

4.7 Final Assembly

After connecting all wirings, then put bottom cover back by screwing two screws as shown below.

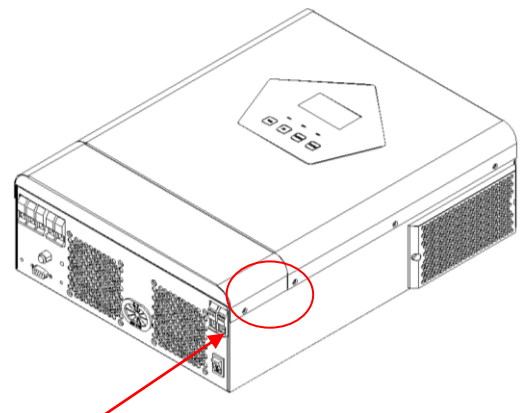
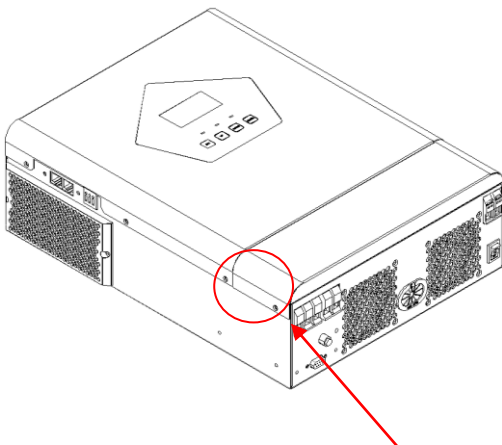

4.8 Dry Contact Signal

There is one dry contact (3A250VAC) available on the rear panel. It could be used to deliver signal to external device when battery reaches warning level.

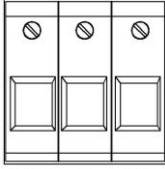
Unit Status	State		
		NC & C	C & NO
Power off	Unit is off and no output is powered	Close	Open
Power on (SBU priority)	Battery voltage < Setting value in Program 12 Program	Open	Close
	Battery voltage > Setting value in Program 13 or battery charging reaches floating stage	Close	Open

4.9 RS232 Communication Connection

Please download software “Watch Power” from the official website. when the inverter is connected to the computer ,the following interface will be displayed.

Note :the following data are for reference only.

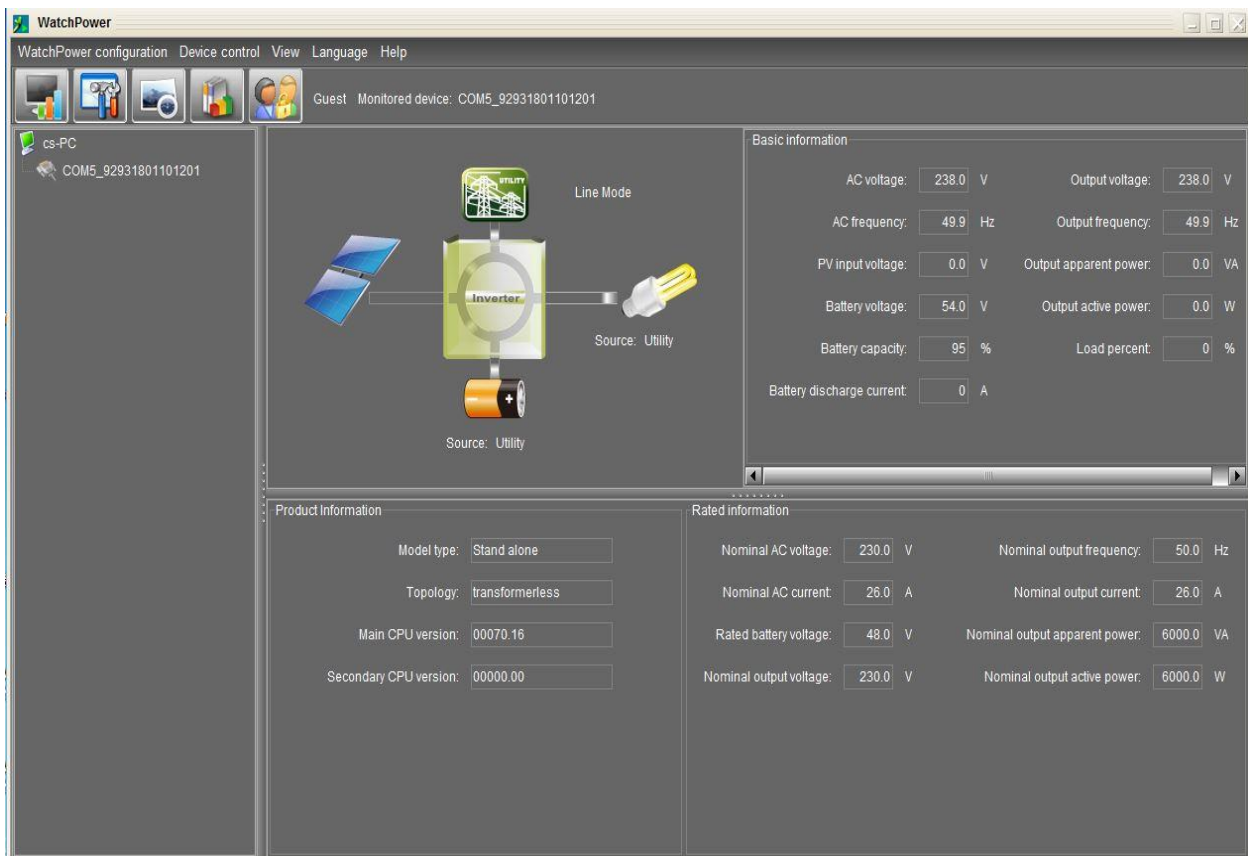

The screenshot displays the WatchPower software interface. The main window shows a central diagram of an inverter system with a battery and a utility source. The interface is divided into several sections:

- Basic information:**
 - AC voltage: 238.0 V
 - Output voltage: 238.0 V
 - AC frequency: 49.9 Hz
 - Output frequency: 49.9 Hz
 - PV input voltage: 0.0 V
 - Output apparent power: 0.0 VA
 - Battery voltage: 54.0 V
 - Output active power: 0.0 W
 - Battery capacity: 95 %
 - Load percent: 0 %
 - Battery discharge current: 0 A
- Product Information:**
 - Model type: Stand alone
 - Topology: transformerless
 - Main CPU version: 00070.16
 - Secondary CPU version: 00000.00
- Rated information:**
 - Nominal AC voltage: 230.0 V
 - Nominal output frequency: 50.0 Hz
 - Nominal AC current: 26.0 A
 - Nominal output current: 26.0 A
 - Rated battery voltage: 48.0 V
 - Nominal output apparent power: 6000.0 VA
 - Nominal output voltage: 230.0 V
 - Nominal output active power: 6000.0 W

4.10 Bluetooth Communication (Optional)

This unit is equipped with a Bluetooth transmitter. Download “RevoMonitor” APP from Google Play . Once the APP is download, you may connect “RevoMonitor” APP to your inverter with the pairing password “1234”.The communication distance is roughly 6 ~ 7 meters.

Note:1.the following date are for reference only.

2.Blutetooth APP only supports Android phone users.

Solar monitor	
Utility voltage: 225.0V	Output Voltage 225.0V
Utility Frequency 49.9Hz	Output Frequency 49.9Hz
Battery Voltage 1.6V	Load Power 0.0W
Battery Current 0.0A	Load Percentage 0.0%
PV1 Voltage 0.0V	PV2 Voltage 0.0V
PV1 Current 0.0A	PV2 Current 0.0A
PV1 Power 0.0W	PV2 Power 0.0W
Work Mode: 03	Warning Code: 03 Error Code: 00
Disconnect	Exit

5. OPERATION

5.1 Power ON/OFF

Once the unit has been properly installed and the batteries are connected well, simply press On/Off switch(located on the button of the case) to turn on the unit.

5.2 Operation and Display Panel

The operation and display panel, shown in below chart, is on the front panel of the inverter. It includes three indicators, four function keys and a LCD display, indicating the operating status and input/output power information.

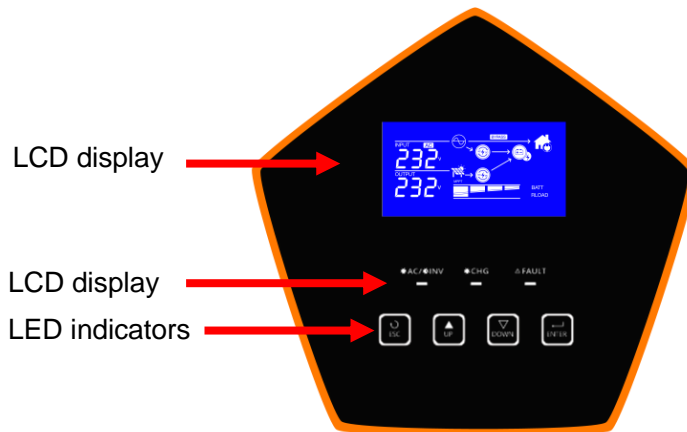

LED Indicator

LED Indicator		Messages	
ac/inv	Green	Solid On	Output is powered by utility mode
		Flashing	Output is powered by battery mode
chg	Green	Solid On	Battery is fully charged
		Flashing	Battery is charging
fault	Red	Solid On	Fault occurs in the inverter
		Flashing	Warning condition occurs in the inverter







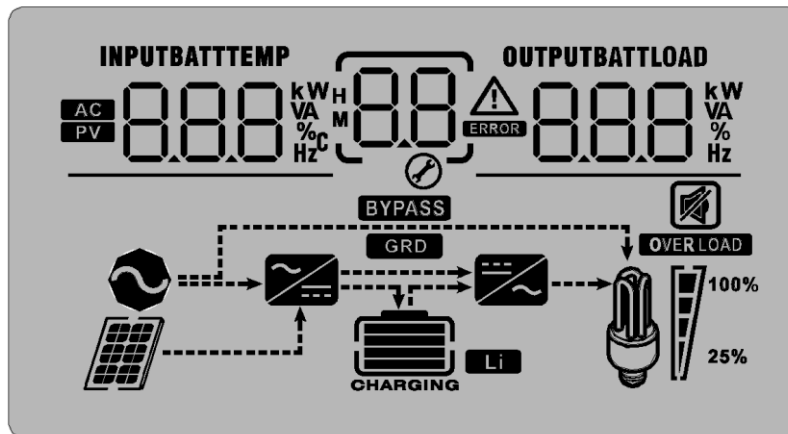







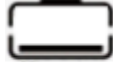





Function Keys

Function Keys	Description
ESC	To exit setting mode
UP	To go to previous selection
DOWN	To go to next selection
ENTER	To confirm the selection in setting mode or enter setting mode

5.3 LCD Display Icons







Icon	Function description
Input Source Information	
	Indicates the AC input
	Indicates the PV input
	Indicate input voltage, input frequency, PV voltage, charger current, battery voltage.
Configuration Program and Fault Information	
	Indicates the setting programs.
	Indicates the warning and fault codes. Warning: flashing with warning code. Fault: lighting with fault code
Output Information	
	Indicate output voltage, output frequency, load percent, load in VA, load in Watt and discharging current.
Battery Information	
	Indicates battery level by 0-24%, 25-49%, 50-74% and 75-100% in battery mode and charging status in line mode.

In AC mode, it will present battery charging status.				
Status	Battery voltage	LCD Display		
Constant Current mode / Constant Voltage mode	<2V/cell	4 bars will flash in turns.		
	2 ~ 2.083V/cell	Bottom bar will be on and the other three bars will flash in turns.		
	2.083 ~ 2.167V/cell	Bottom two bars will be on and the other two bars will flash in turns.		
	> 2.167 V/cell	Bottom three bars will be on and the top bar will flash.		
Floating mode. Batteries are fully charged.		4 bars will be on.		
In battery mode, it will present battery capacity.				
Load Percentage	Battery Voltage	LCD Display		
Load >50%	< 1.85V/cell			
	1.85V/cell ~ 1.933V/cell			
	1.933V/cell ~ 2.017V/cell			
	> 2.017V/cell			
Load < 50%	< 1.892V/cell			
	1.892V/cell ~ 1.975V/cell			
	1.975V/cell ~ 2.058V/cell			
	> 2.058V/cell			
Battery Mode Load Information				
	Indicates overload.			
	Indicates the load level by 0-24%, 25-49%, 50-74% and 75-100%.			
	0%~24%	25%~49%	50%~74%	75%~100%
				
Mode Operation Information				
	Indicates unit connects to the mains.			
	Indicates unit connects to the PV panel.			
	Indicates load is supplied by utility power.			
	Indicates the utility charger circuit is working.			
	Indicates the DC/AC inverter circuit is working.			
Mute Operation				
	Indicates unit alarm is disabled.			







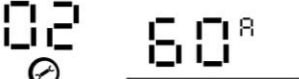

5.4 LCD Setting









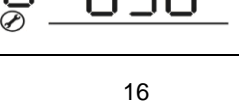

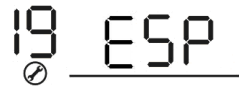
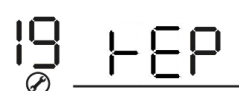

After pressing and holding ENTER button for 3 seconds, the unit will enter setting mode. Press “UP” or “DOWN” button to select setting programs. And then, press “ENTER” button to confirm the selection or ESC button to exit.



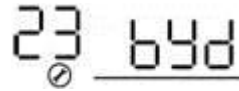





Note: All settings must be modified in battery mode and must be rebooted to be valid.

Program	Description	Selectable option	
00	Exit setting mode	Escape 	
01	Output source priority: To configure load power source priority	Utility first (default) 	Utility will provide power to the loads as first priority. Solar and battery energy will provide power to the loads only when utility power is not available.
		Solar first 	Solar energy provides power to the loads as first priority. If solar energy is not sufficient to power all connected loads, Utility energy will supply power to the loads at the same time.
		Battery first 	Solar energy provides power to the loads as first priority. If solar energy is not sufficient to power all connected loads, battery energy will supply power to the loads at the same time. Utility provides power to the loads only when battery voltage drops to either low-level warning voltage or the setting point in program 12.
02	Maximum charging current: To configure total charging current for solar and utility chargers. (Max. charging current = utility charging current + solar charging current)		
		Default:60A setting range is 10A to 120 A, the increment or decrement is 10A per click.	

03	AC input voltage range	Appliances (default) 03 APL	If selected, acceptable AC input voltage range will be within 90-280VAC.
		UPS 03 UPS	If selected, acceptable AC input voltage range will be within 170-280VAC.
05	Battery type	AGM (default) 05 AGM	Flooded 05 FLD
		User-Defined 05 USE	If "User-Defined" is selected, battery charge voltage and low DC cut-off voltage can be set up in program 26, 27 and 29.
		LIB 05 LIB	
06	Auto restart when overload occurs	Restart disable (default) 06 Lfd	Restart enable 06 LFE
07	Auto restart when over temperature occurs	Restart disable (default) 07 tfd	Restart enable 07 tFE
09	Output frequency	50Hz (default) 09 50 Hz	60Hz 09 60 Hz
10	Output voltage	220V 10 220 ^v	230V (default) 10 230 ^v
		240V 10 240 ^v	
11	Maximum utility charging current Note: If setting value in program 02 is smaller than that in program in 11, the inverter will apply charging current from program 02 for utility charger.	11 30 ^A	Default:30A setting range is 2 A,10A to 100 A, the increment or decrement is 10A per click.
12	Setting voltage point back to utility source when selecting "SBU priority" in program 01.	Available options in 3.5KW model:	
		23.0V(default) 12 BATT 230 ^v	Setting voltage point back 24V model:(default 23.0Vdc) setting range :22.0V to 25.5V setting increase or decrease of 0.5V.

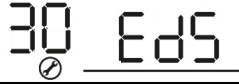
12	Setting voltage point back to utility source when selecting "SBU priority" in program 01.	Available options in 5.5KW model:	
		46.0V(default) 	Setting voltage point back 48V model:(default 46.0Vdc) setting range :44.0V to 51V setting increase or decrease of 1.0V.
13	Setting voltage point back to battery mode when selecting "SBU priority" in program 01.	Available options in 3.5KW model:	
		Battery fully charged 	the battery is full of floating charge
		27.0V (default) 	Setting voltage point back 24V model:(default 46.0Vdc) setting range :24.0V to 29.0V setting increase or decrease of 1.0V.
		Available options in 5.5KW model:	
		Battery fully charged 	the battery is full of floating charge
		54.0V (default) 	Setting voltage point back 48V model:(default 46.0Vdc) setting range :48.0V to 58.0V setting increase or decrease of 1.0V.
16	Charger source priority: To configure charger source priority	If this inverter/charger is working in Line, Standby or Fault mode, charger source can be programmed as below:	
		Utility first 	Utility will charge battery as first priority. Solar energy will charge battery only when utility power is not available.
		Solar first 	Solar energy will charge battery as first priority. Utility will charge battery only when solar energy is not available.
		Solar and Utility (default) 	Solar energy and utility will charge battery at the same time.
		Only Solar 	Solar energy will be the only charger source no matter utility is available or not.

16	Charger source priority: To configure charger source priority	If this inverter/charger is working in Battery mode, only solar energy can charge battery. Solar energy will charge battery if it's available and sufficient.	
18	Alarm control	Alarm on (default) 18 60N 	Alarm off 18 60F 
19	Auto return to default display screen	Return to default display screen (default) 19 ESP 	If selected, no matter how users switch display screen, it will automatically return to default display screen (Input voltage /output voltage) after no button is pressed for 1 minute.
		Stay at latest screen 19 FEP 	If selected, the display screen will stay at latest screen user finally switches.
20	Backlight control	Backlight on (default) 20 LON 	Backlight off 20 LOF 
22	Beeps while primary source is interrupted	Alarm on (default) 22 AON 	Alarm off 22 AOF 
23	Overload bypass: When enabled, the unit will transfer to line mode if overload occurs in battery mode.	Bypass disable (default) 23 BYD 	Bypass enable 23 BYE 
25	Record Fault code	Record enable (default) 25 FEN 	Record disable 25 FdS 
26	Bulk charging voltage (C.V voltage)	3.5K default setting: 28.2V 	
		If self-defined is selected in program 5, this program can be set up. Setting range is from 25.0V to 31.5V Increment of each click is 0.1V.	
		5.5K default setting: 56.4V 	
		If self-defined is selected in program 5, this program can be set up. Setting range is from 48.0V to 61.0V Increment of each click is 0.1V.	

27	Floating charging voltage	3.5K default setting: 27.0V 	
		5.5K default setting: 54.0V 	
		If self-defined is selected in program 5, this program can be set up. Setting range is from 25.0V to 31.5V for 3.5KVA model and 48.0V to 61.0V for 5.5KVA model. Increment of each click is 0.1V.	
29	Low DC cut-off voltage	3.5K default setting: 21.0V 	
		5.5K default setting: 42.0V 	
		If self-defined is selected in program 5, this program can be set up. Setting range is from 21.0V to 24.0V for 3.5KVA model and 42.0V to 48.0V for 5.5KVA model. Increment of each click is 0.1V. Low DC cut-off voltage will be fixed to setting value no matter what percentage of load is connected.	
30	Battery equalization	Battery equalization 	Battery equalization disable (default) 
		If "Flooded" or "User-Defined" is selected in program 05, this program can be set up.	
31	Battery equalization voltage	3.5KVA default setting: 29.2V 	
		5.5KVA default setting: 58.4V 	
		Setting range is from 25.0V to 31.5V for 3.5KVA model and 48.0V to 61.0V for 5.5KVA model. Increment of each click is 0.1V.	
33	Battery equalized time	60min (default) 	Setting range is from 5min to 900min. Increment of each click is 5min.
34	Battery equalized timeout	120min (default) 	Setting range is from 5min to 900 min. Increment of each click is 5 min.

35	Equalization interval	30days (default) 35 30d	Setting range is from 0 to 90 days. Increment of each click is 1 day.
36	Equalization activated immediately	Enable 36 AEN	Disable (default) 36 AdS
		If equalization function is enabled in program 30, this program can be set up. If "Enable" is selected in this program, it's to activate battery equalization immediately and LCD main page will shows "E9". If "Disable" is selected, it will cancel equalization function until next activated equalization time arrives based on program 35 setting. At this time, "E9" will not be shown in LCD main page.	
40	Discharge limited current	40 OFF	OFF: default ; discharge current limited disable
		40 10 ^A	setting range :10A to 200A setting increase or decrease of 5A . NOTE:1. if you work in "PV priority mode" or "SBU priority mode", when the loads is greater than the current limiting point, it will automatically switch to utility mode. 2.if it only works in battery mode,when the load is greater than the current limiting point,the inverter will shut down immediately.
41	Lithium battery discharge stop	41 6	Default:6% 1.When the battery capacity of the lithium battery is lower than the set point, the inverter stops discharging and output will be turned off. setting range :1% to 60% setting increase or decrease of 1%. 2.when the communication connection between the lithium battery and the inverter is normal,"USER" will be displayed next to the battery icon on ten display screen
42	Lithium battery charge stop	44 00 42 96	Default:96% 1.When the battery capacity of the lithium battery is higher than the set point, the inverter stops charging setting range :60% to 100% setting increase or decrease of 1%. 2.when the communication connection between the lithium battery and the inverter is normal,"USER" will be displayed next to the battery icon on ten display screen
44	Reconnection delay time	44 00	When the utility is connected, the waiting time can be set. After reaching the waiting time, the utility will start working. Range:0-999S

50	Battery activation	Activation activation (default)	Activation activation: When the AC is connected to the inverter and turned it on. And if the battery cannot be detected, the battery will be activated. (If it fails, disconnect AC and restart)
		on	Manual activation : In this mode, select "On", connect the AC or PV to the inverter, and turn it on. If the battery is not detected, an activation of the battery is performed. "Off" will be returned if activation is successful or fail
		Off	

5.5 Fault Reference Code

Fault Code	Fault Event
01	Fan is locked when inverter is off.
02	Over temperature
03	Battery voltage is too high
04	Battery voltage is too low
05	Output short circuited or over temperature is detected by internal converter components.
06	Output voltage is too high.
07	Overload time out
08	Bus voltage is too high
09	Bus soft start failed
51	Over current or surge
52	Bus voltage is too low
53	Inverter soft start failed
55	Over DC voltage in AC output
57	Current sensor failed
58	Output voltage is too low
59	PV voltage is over limitation

5.6 Battery Equalization Description

Battery equalization function is built into the charge controller. It reverses the buildup of negative chemical effects such as stratification, a condition where acid concentration is greater at the bottom of the battery than at the top. Equalization also helps to remove sulfate crystals that may have built up on the plates. If left unchecked, this condition, called sulfating, will reduce the overall capacity of the battery. Therefore, it's recommended to equalize the battery periodically.

How to Activate Equalization Function

You must enable battery equalization function in LCD setting Program 30 first. Then you can apply this function by either one of the following methods.

1. Setting equalization interval in Program 35.
2. Activate equalization immediately in Program 36.

When to Equalize

In floating charge stage, when setting the equalization interval (battery equalization cycle) is reached, or equalization is activated immediately, the controller will start to enter Equalize Mode.

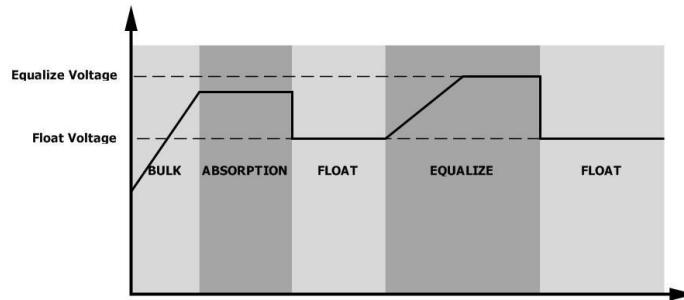

Equalize Charging and Timeout

In Equalize Mode, the controller will supply power to charge battery as much as possible until battery voltage reach the equalization voltage. Then, constant-voltage regulation is applied to maintain battery voltage at the equalization level. The battery will remain in the Equalize Mode until the equalization timer runs out.

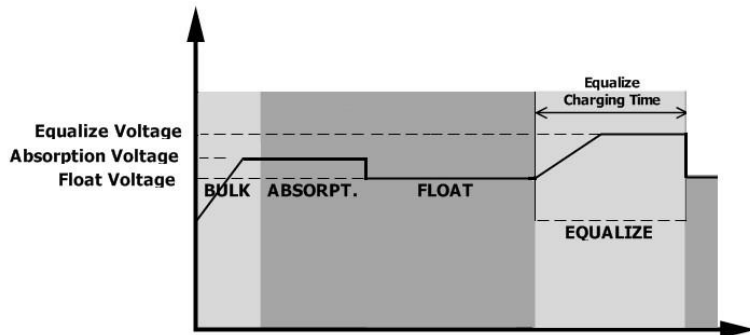

However, in Equalize Mode, if the battery equalization timer runs out and the battery voltage doesn't recover to the battery equalization voltage point, the charge controller will extend the battery equalized time until battery voltage to equalization voltage. If the battery voltage is still lower than equalization voltage when the extension runs out, the charge controller will stop equalization and return to the floating charging stage.

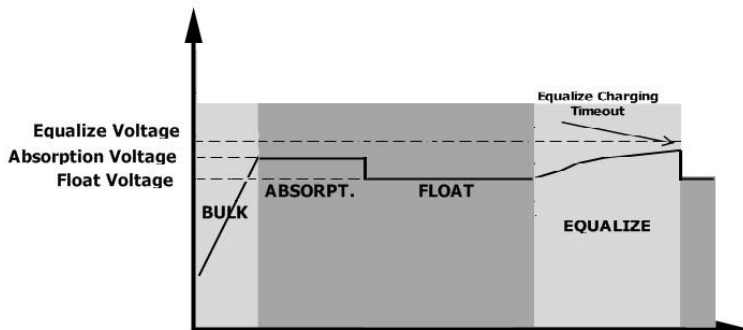

5.7 Warning Indicator

Warning Code	Warning Event
01	Fan is locked when inverter is on.
02	Over temperature
03	Battery is over-charged
04	Low battery
07	Overload
08	Discharge current limiting
10	Output power derating
15	PV energy is low
16	High AC input (>280VAC) during BUS soft start
E9	Battery equalization
bP	Battery is not connected

6.TROUBLE SHOOTING

Problem	LCD/LED/Buzzer	Explanation / Possible cause	What to do
Unit shuts down automatically during startup process.	LCD/LEDs and buzzer will be active for 3 seconds and then complete off.	The battery voltage is too low (<1.91V/Cell)	1. Re-charge battery. 2. Replace battery.
No response after power on.	No indication.	1. The battery voltage is far too low. (<1.4V/Cell) 2. Internal fuse tripped.	1. Contact repair center for replacing the fuse. 2. Re-charge battery. 3. Replace battery.
Mains exist but the unit works in battery mode.	Input voltage is displayed as 0 on the LCD and green LED is flashing.	Input protector is tripped	Check if AC breaker is tripped and AC wiring is connected well.
	Green LED is flashing.	Insufficient quality of AC power. (Shore or Generator)	1. Check if AC wires are too thin and/or too long. 2. Check if generator (if applied) is working well or if input voltage range setting is correct.
	Green LED is flashing.	Set "SUB" (solar first) as the priority of output source.	Change output source priority to "USB" (utility first).
When the unit is turned on, internal relay is switched on and off repeatedly.	LCD display and LEDs are flashing	Battery is disconnected.	Check if battery wires are connected well.
Buzzer beeps continuously and red LED is on.	Fault code 07	Overload error. The inverter is overload 110% and time is up.	Reduce the connected load by switching off some equipment.
		If PV input voltage is higher than specification, the output power will be derated. At this time, if connected loads is higher than derated output power, it will cause overload.	Reduce the number of PV modules in series or the connected load.
	Fault code 05	Output short circuited.	Check if wiring is connected well and remove abnormal load.
		Temperature of internal converter component is over 120°C.	Check whether the air flow of the unit is blocked or whether the ambient temperature is too high.
Fault code 02	Internal temperature of inverter component is over 100°C.		

Buzzer beeps continuously and red LED is on.	Fault code 03	Battery is over-charged.	Return to repair center.
		The battery voltage is too high.	Check if spec and quantity of batteries are meet requirements.
	Fault code 01	Fan fault	Replace the fan.
	Fault code 06/58	Output abnormal (Inverter voltage below than 190Vac or is higher than 260Vac)	1. Reduce the connected load. 2. Return to repair center
	Fault code 08/09/53/57	Internal components failed.	Return to repair center.
	Fault code 51	Over current or surge.	Restart the unit, if the error happens again, please return to repair center.
	Fault code 52	Bus voltage is too low.	
	Fault code 55	Output voltage is unbalanced.	
	Fault code 59	PV input voltage is beyond the specification.	Reduce the number of PV modules in series.

7. SPECIFICATIONS

Table 1 Solar Mode Specifications

MODEL	3.5KW24VDC	5.5KW48VDC
Rated output power	5500W	
Normal output voltage	230VAC	
Output voltage range	230 ± 5%VAC	
Normal output current	15.2A	24.0A
PV Input Max Power	5500W	
PV Array MPPT Voltage Range	60-450VDC	
Start-up Voltage	70Vdc +/- 5Vdc	
Nominal PV Voltage	240Vdc	330Vdc
Max. PV Array Open Circuit Voltage	500Vdc	
Overload protection	MPPT will close immediately as long as the input power is greater than the maximum output power	
PV Max input current	18A	

Table 2 Line Mode Specifications

Input Voltage Waveform	Pure sine wave (utility or generator)
Normal Input Voltage	230VAC
Low Loss Voltage	90VAC±7V (wide range) 170VAC±7V(narrow range)
Low Loss Return Voltage	100VAC±7V (wide range) 180VAC±7V(narrow range)
High Loss Voltage	280VAC±7V
High Loss Return Voltage	270VAC±7V
Max AC Input Voltage	300VAC
Normal Input Frequency	50Hz / 60Hz (Auto detection)
Low loss Frequency	40±1Hz
Low loss Return Frequency	42±1Hz
High loss Frequency	65±1Hz
High loss Return Frequency	63±1Hz
Output short circuit protection	Circuit Breaker
Efficiency (Line Mode)	>95% (Rated R load, battery full charged)
Communication	RS232 and RS485 or CAN, Bluetooth and WIFI
Humidity	0-90% RH(No-condensing)
Operation temperature	-10°C to 50°C
Storage temperature	-15°C-50°C
Humidity	5% to 95% Relative Humidity (Non-condensing)
<p>Output power derating: When AC input voltage drops to 170V, the output power will be derated.</p>	<p>The graph illustrates the output power derating characteristics. The vertical axis represents Output Power, with two specific levels marked: 50% Power and Rated Power. The horizontal axis represents Input Voltage, with three key points marked: 90V, 170V, and 280V. The power remains constant at a low level until 90V, then increases linearly to reach the Rated Power level at 170V. It remains constant at the Rated Power level until 280V, after which it drops to zero.</p>

Table 3 Charge Mode Specifications

INVERTER MODEL		3.5KW	5.5KW
Charging Algorithm		3-Step	
Utility Charging Mode			
AC Charging Current		2/10/20/30/40/50/60/70A/80/90/100Amp (@V _{IP} =230Vac)	
Bulk Charging Voltage	Flooded Battery	29.2VDC	58.4VDC
	AGM / Gel Battery	28.2VDC	56.4VDC
Floating Charging Voltage		27.0VDC	54.0VDC
Charging Curve			
Max. charging current(Solar+AC)		120A	

Table 4 Inverter Mode Specifications

Normal DC voltage		24V	48V
Waveform		Pure sine wave	
Output voltage range		230VAC±5%	
Output frequency		50/60Hz±1Hz	
Peak Efficiency		93%	
Power factor		1.0	
Overload protection		10s@110%~130% load , 5s@130%~200% load, 200ms@≥200% load	
Transfer time		10ms typical (narrow range) 20ms typical (wide range)	
Protection features		Low voltage protection; High voltage protection Overload protection ; Over-temperature protection Short circuit protection; Over-charge protection	
Cold start voltage		23.0VDC	46.0VDC
Low DC Warning Voltage	load < 50%	23.0VDC	46.0VDC
	load ≥ 50%	22.0Vdc	44.0Vdc
Low DC Warning Return Voltage	load < 50%	23.5Vdc	47.0Vdc
	load ≥ 50%	23.0Vdc	46.0Vdc
Low DC Cut-off Voltage	load < 50%	21.5Vdc	43.0Vdc
	load ≥ 50%	21.0VDC	42.0VDC
High DC Recovery Voltage		32.0VDC	62.0VDC
High voltage Cut-off Voltage		33.0VDC	63.0VDC
Dimension(LxWxH)mm		421*302*137	
Net Weight (KG)		7.5	9
Gross Weight (KG)		8.5	10

8.Installation Dimension Drawing

NOTE:The following picture is only a schematic diagram of the equipment .If the actual chassis does not conform to the schematic due to a structural upgrade, it is subject to prior notice.

