

USER MANUAL

EM-3224 S1-ECO SOLAR INVERTER



Version:1.0

Table Of Contents

1. About This Manual	1
1.1 Purpose	1
1.2 Scope	1
1.3 Safety Instructions.....	1
2. Introduction	1
2.1 Features	1
2.2 Basic System Architecture	1
2.3 Product Overview.....	3
3. Installation.....	4
3.1 Unpacking And Inspection	4
3.2 Preparation.....	4
3.3 Mounting The Unit.....	4
3.4 Battery Connection.....	5
3.4 AC Input/output Connection	6
3.5 PV Connection	6
3.6 Final Assembly	8
3.7 RS232 Communication Connection.....	9
3.8 Wi-Fi Connection (Optional).....	9
4. Operation	10
4.1 Power ON/OFF.....	10
4.2 Operation And Display Panel.....	10
4.3 LCD Display Icons.....	11
4.4. LCD Setting	12
4.5 Display Setting	18
4.6 Operating Mode Description	21
4.7 Battery Equalization Description	22
5. Fault Reference Code	24
6. Warning Indicator	25
7. Trouble Shooting.....	26
8. Line Mode Specification	28
9. Inverter Mode Specification	29
10. Charge Mode Specification	30
11. Solar Mode Specifications.....	31
12. General Specifications	31
13. Installation Dimension Drawing.....	32

1. About This Manual

1.1 Purpose

This manual describes how to assemble, install and operate the units and how to troubleshoot of this unit. Please read this manual carefully before installation and operation. Keep this manual for future reference.

1.2 Scope

This manual provides guidelines of safety installation as well as the information on tools and wiring.

1.3 Safety Instructions

WARNING: This chapter contains important safety and operating instructions. Read and keep this manual for future reference.

1. Read and follow all installation, operation, and maintenance information carefully before using the product.
2. **CAUTION:** To reduce risk of injury, charge only deep-cycle lead acid type rechargeable batteries. Other types of batteries may burst, causing personal injury and damage.
3. Do not disassemble the unit personally. Take it to a qualified service center to repair.
4. To reduce risk of electric shock, disconnect all wiring before attempting any maintenance or cleaning, turning off the unit will not reduce this risk.
5. **WARNING :** Disconnecting all power supply before any maintaining or cleaning, please noted that if you only turn off the unit are not safe enough.
6. **WARNING:** Only qualified service persons are allowed to operate this product. If fault not solved after following troubleshooting table, please send this inverter back to local dealer or service center for maintenance.
7. **WARNING:** Because this inverter is non-isolated, only three types of PV modules are adaptable: single crystalline, poly crystalline with class A-rated and CIGS modules. To avoid any malfunction, do not connect any PV modules which likely with current leakage flow to the inverter. For example, grounded PV modules may cause current leakage flow to the inverter. When using CIGS modules, please be sure of NO grounding.
8. **CAUTION:** It's requested to use PV junction box with surge protection. Otherwise, it may cause damage on inverter.

2. Introduction

This is a multi-function inverter/charger; combining various of functions of inverter, solar charger and battery charger. Supply uninterruptible electric energy to loads. It's comprehensive LCD display allowed user setting the various date according to user's requirements, such as battery charging current, AC/solar charger priority, and setting different input voltage based on different applications.

2.1 Features

1. Off grid pure sine wave inverter
2. Output power factor $\cos \phi = 1.0$
3. Configurable AC/Solar Charger priority via LCD setting
4. Smart battery charger design for optimized battery performance
5. Compatible to mains voltage or generator power
6. Overload, over temperature, short circuit protection, battery low voltage
7. External WIFI devices (option)
8. Cold start function
9. Auto restart while AC is recovering

2.2 Basic System Architecture

The following illustration shows basic application for this inverter/charger. It also includes following devices to have a complete running system:

Generator or Utility. PV modules

Consult with integrators who provide you the system about the architectures as you request. This inverter can supply power to all kinds of appliances in home or office, including motor-type appliances, such as tube light, fan, refrigerator and air-conditioner.

NOTE: The following picture is only a schematic diagram of the equipment. If the actual chassis does not conform to the schematic due to a structural upgrade; it is subject to prior notice.

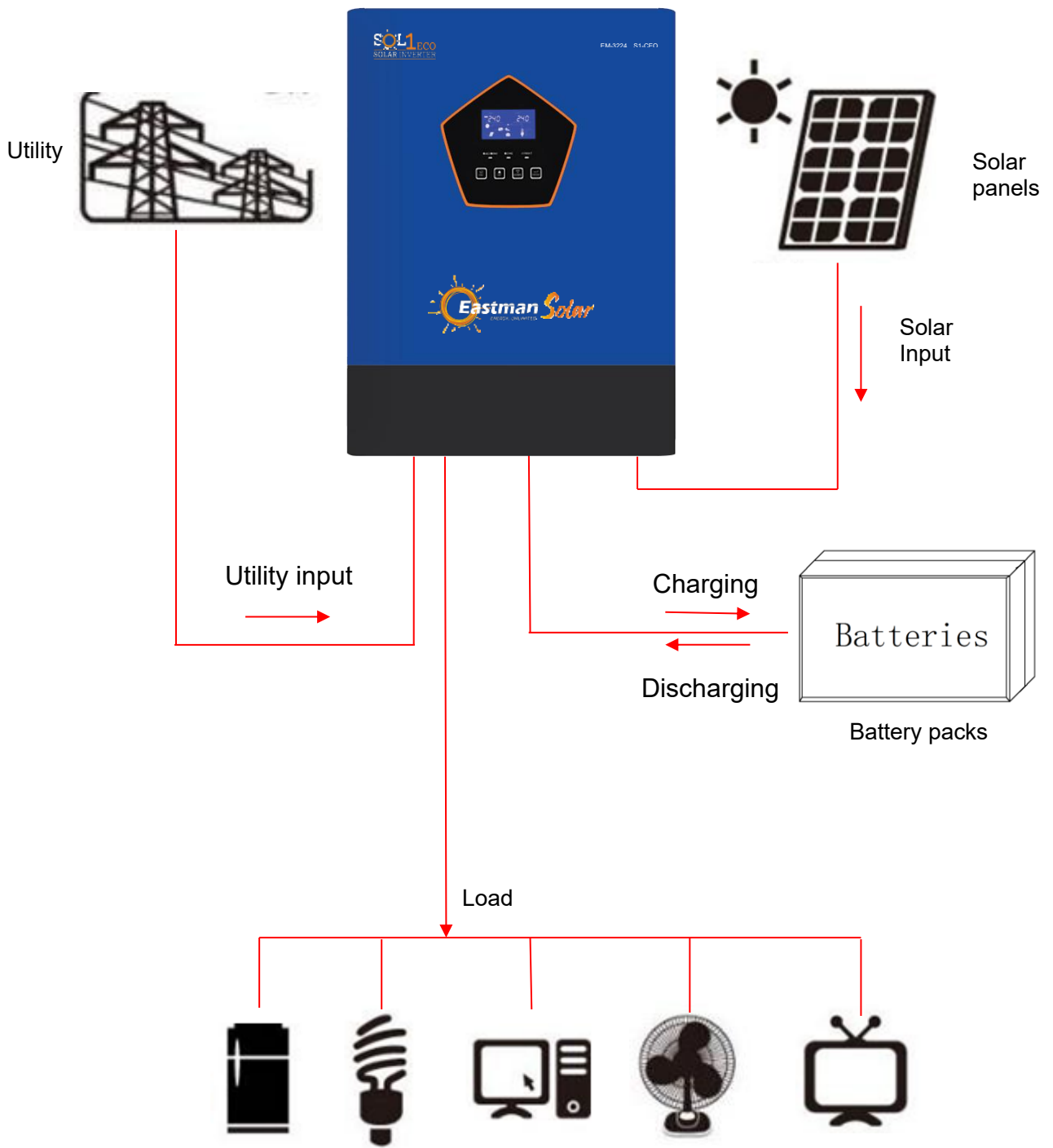

Figure 1: Hybrid power system

2.3 Product Overview

NOTE: the following picture is only a schematic diagram of the equipment .If the actual chassis does not conform to the schematic due to a structural upgrade. It's subject to prior notice.

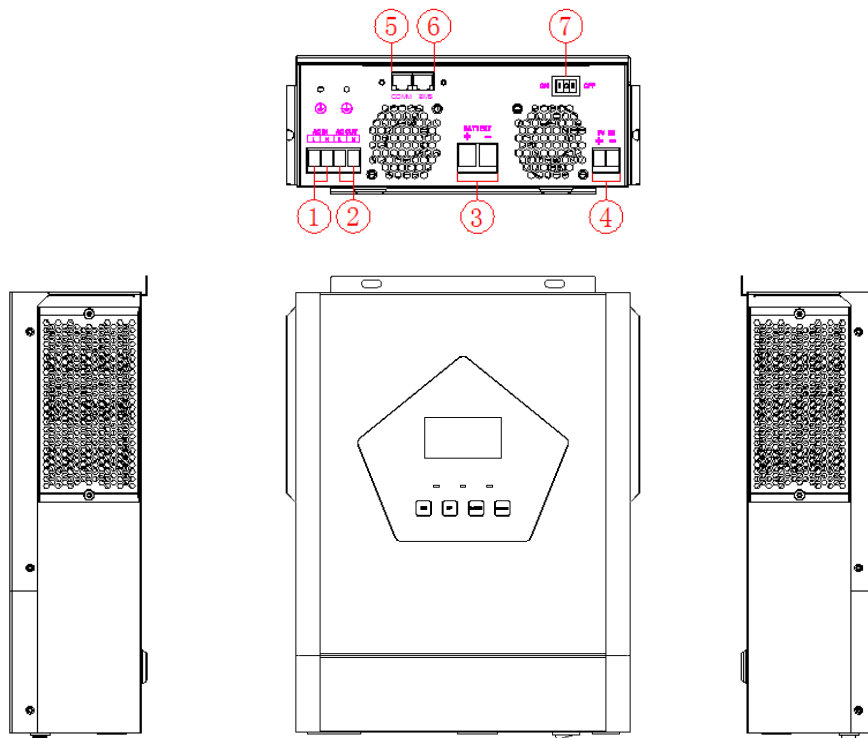
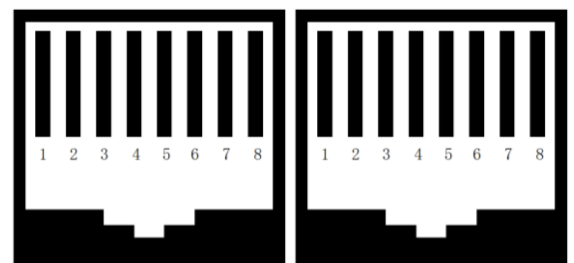

Figure 2:1.6K/3.2K model

1. AC input terminal
2. AC output terminal
3. Battery input
4. PV input terminal
5. COMM communication port
6. BMS communication port
7. Power on/off switch

Communication port definition:

COMM: RS232	1:RXD, 2:TXD , 4:+VCC ,8:GND
BMS: RS485 CAN	1:485-B , 2: 485-A, 4: CAN-H , 5: CAN-L ,



COMM

BMS

3.Installation

3.1 Unpacking And Inspection

Before installation, please inspect the unit. Be sure that nothing inside the package is damaged. You should have received the following items inside of package:

- The inverter x1
- User manual x 1

3.2 Preparation

Remove the two screws on both sides of the bottom cover before connecting all wires.

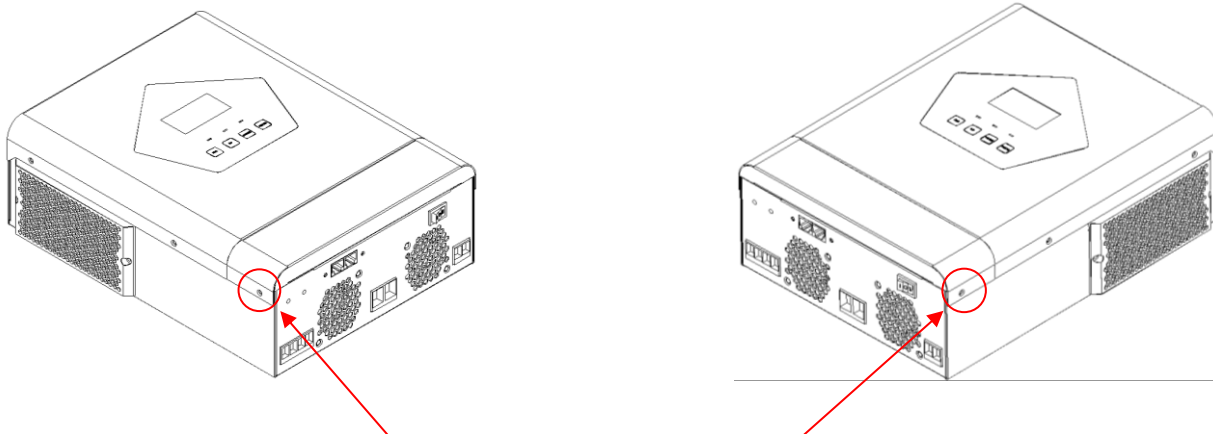

3.3 Mounting The Unit

Consider the followings before selecting your placements:

- 1.Do not mount the inverter on flammable construction
- 2.Mount on solid surface
- 3.Install the inverter at eye level in order to allow easy LCD display readout.
- 4.For proper air circulation and heat dissipation, allow a clearance of approx. 20 cm to the side and approx. 50cm above and below the unit.
- 5.The ambient temperature should be between 0°C And 50°C to ensure optimal operation.
- 6.The recommended orientation is to adhered to the wall vertically.

Be sure to keep other objects and surfaces as shown in the diagram to guarantee sufficient heat dissipation and to have enough space for wiring.

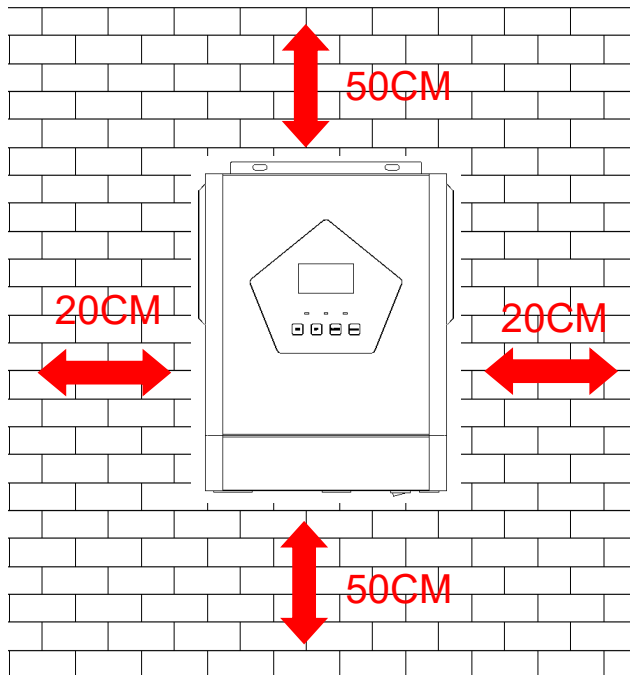

Note: suitable for mounting on concrete or other non-combustible surface only.

Install the unit by screwing two screws. It's recommended to use M4 or M5 screws.

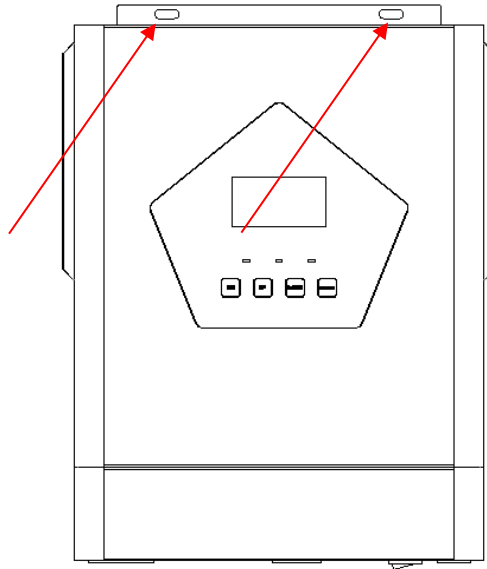

3.4 Battery Connection

CAUTION: for safety operation and regulation compliance, it's requested to install a separate DC over-current protector or disconnection device between battery and the inverter. It may not be necessary to have a disconnection device in some applications; but, it's still recommended to have over-current protection installed.

WARNING! All wiring must be performed by a qualified personnel.

WARNING! It's very important for system safety and efficient operation to use appropriate cable for battery connection. To reduce risk of injury, please use the proper recommended cable.

Recommended battery cable:

Model	Max. discharge current	Battery capacity	Wire size(AWG)	Wire size(mm ²)
1.6KW12V	145A	200AH	1*3AWG	1*35
3.2KW24V	145A	200AH	1*3AWG	1*35

Please follow below steps to implement battery connection:

1. 1.6KW model supports 12VDC system and 3.2KW model supports 24VDC system. Connect all battery packs as below chart. It is recommended connecting minimum of 200Ah capacity battery for 1.6KW model and for 3.2KW model.

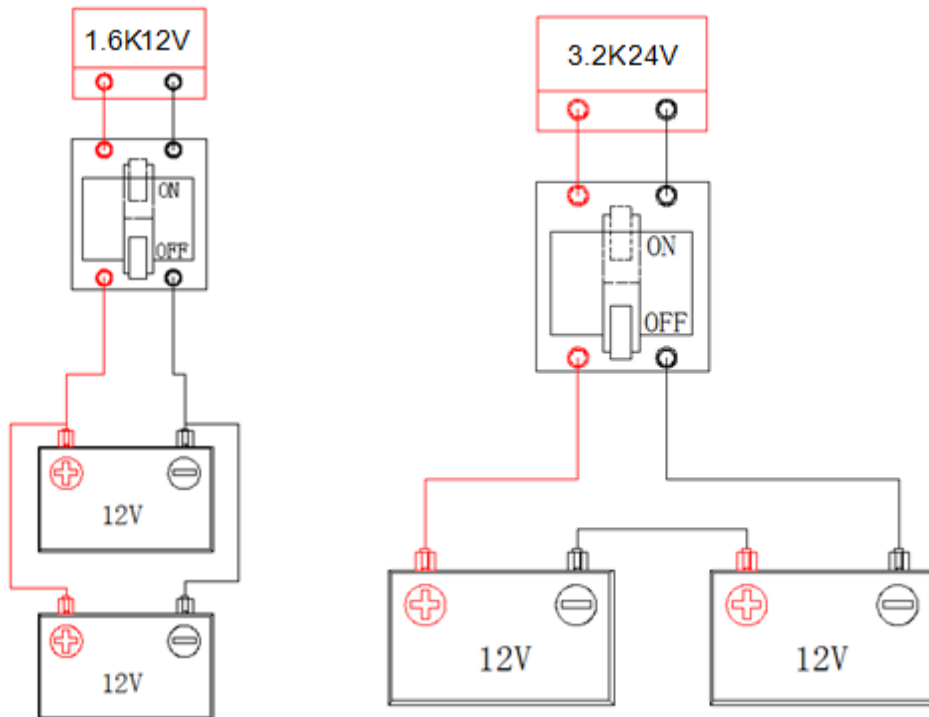

2. Prepare two battery wires for 1.6KW model and 3.2KW model depending on cable size (refer to recommended cable size table). Apply Tube type terminals to your battery wires and secure it to the battery terminal block with the bolts properly tightened. Refer to battery cable size for torque value. Make sure polarity at both the battery and the inverter is correctly connected and ring terminals are secured to the battery terminals.

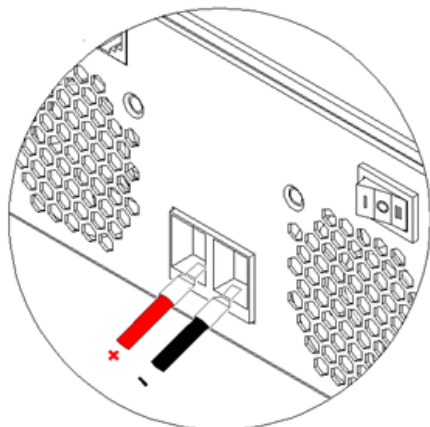

WARNING: Shock Hazard

Installation must be performed with care due to high battery voltage in series.

CAUTION!! Do not place anything between the flat part of the inverter terminal and the Tube type terminal. Otherwise, overheating may occur.

CAUTION!! Do not apply anti-oxidant substance on the terminals before terminals are connected tightly.

CAUTION!! Before making the final DC connection or closing DC breaker/disconnect or, be sure positive (+) must be connected to positive (+) and negative (-) must be connected to negative(-).

3.4 AC Input/output Connection

CAUTION!! Before connecting to AC input power source, please install a separate AC breaker between inverter and AC input power source. This will ensure the inverter can be securely disconnected during maintenance and fully protected from over current of AC input. The recommended spec of AC breaker is 15A for 1.6KW and 30A for 3.2KW.

CAUTION!! There are terminal blocks with “IN” and “OUT” markings. Please do NOT mis-connect input and output connectors.

CAUTION!! High touch current, earth connection essential before connection supply.

WARNING! All wiring must be performed by a qualified personnel.

WARNING! It's very important for system safety and efficient operation to use appropriate cable for AC input connection. To reduce risk of injury, please use the proper recommended cable size as below.

Model	Gauge	Cable (mm ²)	Torque Value (Max.)
1.6KW/3.2KW	12 AWG	4	1.0-1.2Nm

3.5 PV Connection

CAUTION: It is forbidden for multiple inverters to share the same solar panel group.

CAUTION: Before connecting to PV modules, please install separately a DC circuit breaker and lightning arrester between inverter and PV modules.

WARNING: It's very important for system safety and efficient operation to use appropriate cable for PV module connection. to reduce risk of injury, please use the proper cable size as below.

Model	Wire Size	Cable (mm ²)	Torque value (max.)
1.6KW/3.2KW	12AWG	4	1.0-1.2 Nm

CAUTION: It's requested to use PV junction box with surge protection. Otherwise, it will cause damage on inverter when lightning occurs on PV modules.

PV Module Selection:

When selecting proper PV modules, please be sure to consider below parameters:

Open circuit Voltage (Voc) of PV modules not exceeds max. PV array open circuit voltage of inverter.

Inverter Model	1.6K12Vdc	3.2K24Vdc
Max. PV Array Power	2000W	3500W
Max. PV Array Open Circuit Voltage	500Vdc	
PV Array MPPT Voltage Range	60Vdc~450Vdc	

Application Example 1:

Solar Panel Specifications c. 250Wp Vmpp: 30 Vdc Impp: 8.3A Voc:37.0Vdc Isc:8.5A	SOLAR INPUT	Q'ty of panels	Total input power
	(Min. in serial: 5 pcs, max. in serial: 12 pcs)		
	5pcs in serial	5 pcs	1250W
	6pcs in serial	6 pcs	1500W
	8pcs in serial	8 pcs	2000W
	10pcs in serial	10 pcs	2500W
	12pcs in serial	12 pcs	3000W

Application Example 2:

Solar Panel Specifications c. 550Wp Vmp: 41.96Vdc Imp: 13.11A Voc:49.9Vdc Isc:14A	SOLAR INPUT	Q'ty of panels	Total input power
	(Min. in serial: 2 pcs, max. in serial: 9 pcs)		
	2pcs in serial	2 pcs	1100W
	3pcs in serial	3 pcs	1650W
	3pcs in serial	4 pcs	2200W
	5pcs in serial	5 pcs	2750W
	6pcs in serial	6 pcs	3300W

PV Module Wire Connection

Please follow below steps to implement PV module connection:

1. Remove insulation sleeve 10 mm for positive and negative conductors.
2. Suggest to put bootlace ferrules on the end of positive and negative wires with a proper crimping tool.
3. Fix PV wire cover to the inverter with supplied screws as shown in below chart.



3. Check polarities of wire connections from PV modules to PV input screw terminals. Connect your wires as illustrated below.

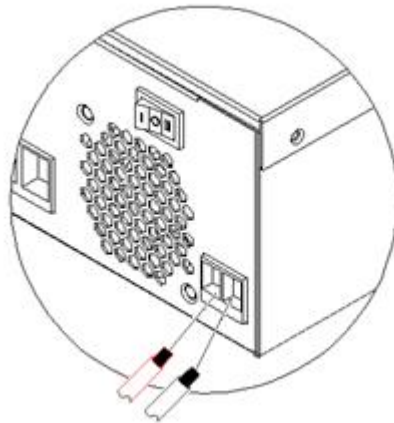

3.6 Final Assembly

After connecting all wirings, then put bottom cover back by screwing two screws as shown below.

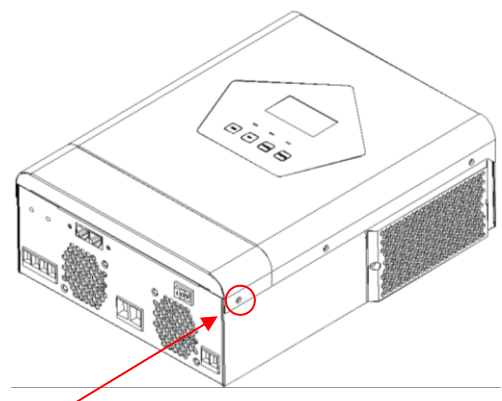
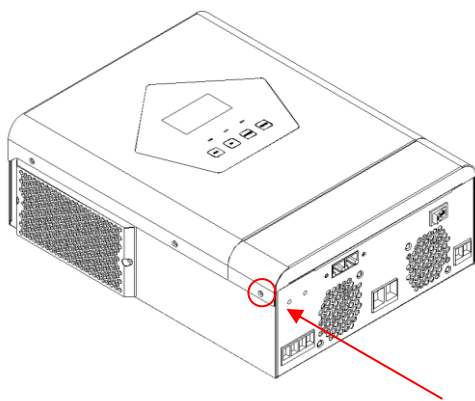

3.7 RS232 Communication Connection

Please download software “Watch Power” from the official website. When the inverter is connected to the computer, the following interface will be displayed.

Note: The following dates are for reference only.

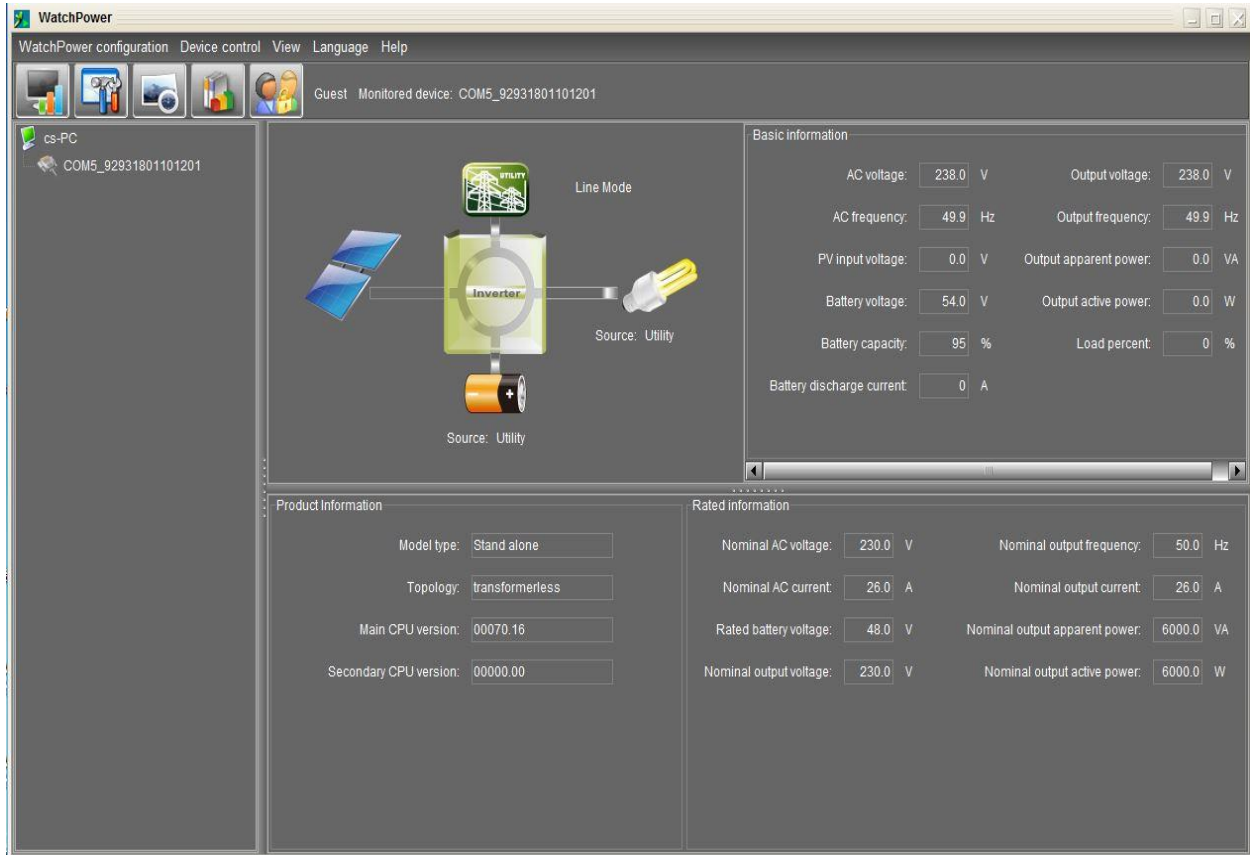

3.8 Wi-Fi Connection (Optional)

1. The device has its own standard WIFI port, if users need to monitor the status and information of the device through WIFI, they must connect to the WIFI collector.
2. Users can download “**SmartEss**” WIFI monitoring software from the app store on their phone.
3. Inverters come equipped with factory-integrated Wi-Fi capability which makes it very easy to integrate into a home network (Wi-Fi Dongle is Optional) This makes it ideal for local monitoring via the inverter's own wireless home network or for online monitoring platforms.

4. Operation

4.1 Power ON/OFF

Once the device has been properly installed and the battery is connected, simply press the Power button to turn on the device.

4.2 Operation And Display Panel

The operation and display panel, shown in below chart, is on the front panel of the inverter. It includes three indicators, four function keys and a LCD display.

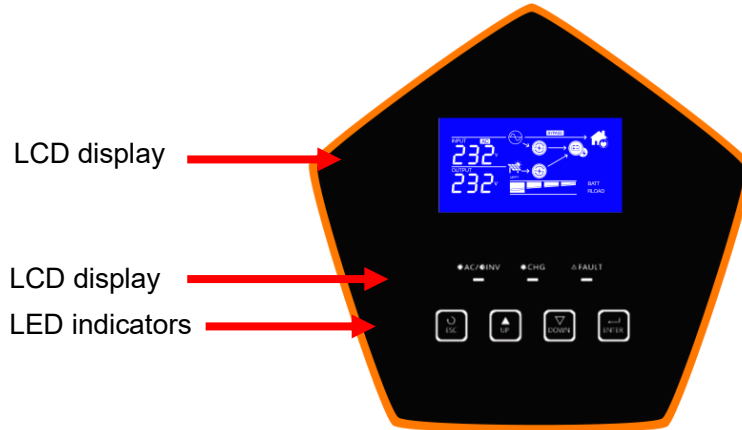

LED Indicator

LED Indicator		Messages	
ac/inv	Green	Solid On	Output is powered by utility mode
		Flashing	Output is powered by battery mode
chg	Green	Solid On	Battery is fully charged
		Flashing	Battery is charging
fault	Red	Solid On	Fault occurs in the inverter
		Flashing	Warning condition occurs in the inverter





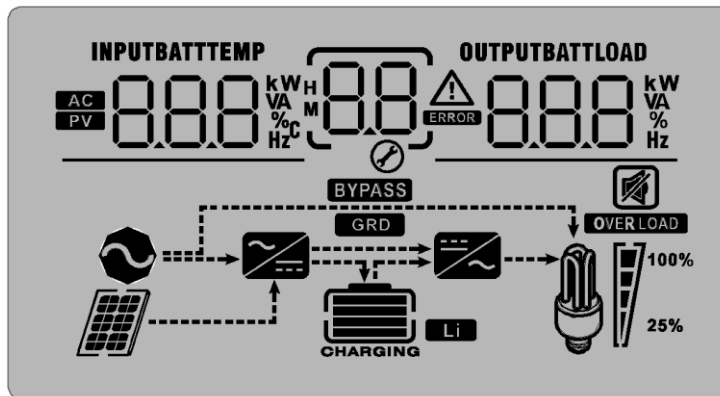

Function Keys

Function Keys	Description
ESC	To exit setting mode
UP	To go to previous selection
DOWN	To go to next selection
ENTER	To confirm the selection in setting mode or enter setting mode

4.3 LCD Display Icons



Icon	Function description			
Input Source Information				
AC	Indicates the AC input.			
PV	Indicates the PV input			
INPUTBATT 888 kW VA %C Hz	Indicate input voltage, input frequency, PV voltage, charger current, battery voltage.			
Configuration Program and Fault Information				
88	Indicates the setting programs.			
88 ⚠	Indicates the warning and fault codes.			
88 ⚠	Warning: flashing with warning code.			
88 ERROR	Fault: lighting with fault code			
Output Information				
OUTPUTBATTLLOAD 888 kW VA % Hz	Indicate output voltage, output frequency, load percent, load in VA, load in Watt and discharging current.			
Battery Mode Information				
	Indicates battery level by 0-24%, 25-49%, 50-74% and 75-100% in battery mode and charging status in line mode.			
Battery mode load information				
OVER LOAD	Indicates overload.			
	Indicates the load level by 0-24%, 25-49%, 50-74% and 75-100%.			
	0%~24%	25%~49%	50%~74%	75%~100%

Mode Operation Information	
	Indicates unit connects to the mains.
	Indicates unit connects to the PV panel.
	Indicates load is supplied by utility power.
	Indicates the utility charger circuit is working.
	Indicates the DC/AC inverter circuit is working.
Mute Operation	
	Indicates unit alarm is disabled.

4.4. LCD Setting

After pressing and holding ENTER button for 3 seconds, the unit will enter setting mode. Press “UP” or “DOWN” button to select setting programs. And then, press “ENTER” button to confirm the selection or ESC button to exit.

Setting Programs:





Program	Description	Selectable option	
00	Exit setting mode	Escape 00 ESC	
01	Output source priority: To configure load power source priority	Utility first (default) 01 UTI	Utility will provide power to the loads as first priority. Solar and battery energy will provide power to the loads only when utility power is not available.
		Solar first 01 SOL	Solar energy provides power to the loads as first priority. If solar energy is not sufficient to power all connected loads, Utility energy will supply power to the loads at the same time.
		Battery priority 01 SBU	Solar energy provides power to the loads as first priority. If solar energy is not sufficient to power all connected loads, battery energy will supply power to the loads at the same time. Utility provides power to the loads only when battery voltage drops to either low-level warning voltage or the setting point in program 12.
02	Maximum charging current (= utility charging current + solar charging current)	Default: 02 60 ^A	Setting range is from 10A to 100A. Increment of each click is 10A.

03	AC input voltage range	Appliances (default) 03 APL	If selected, acceptable AC input voltage range will be within 90-280VAC.
		UPS 03 UPS	If selected, acceptable AC input voltage range will be within 170-280VAC.
05	Battery type	AGM (default) 05 AGM	Flooded 05 FLD
		User-Defined 05 USE	If "User-Defined" is selected, battery charge voltage and low DC cut-off voltage can be set up in program 26, 27 and 29.
		LIB 05 LIB	
06	Auto restart when overload occurs	Restart disable(default) 06 LTD	Restart enable 06 LTE
07	Auto restart when over temperature occurs	Restart disable(default) 07 LTD	Restart enable 07 LTE
09	Output frequency	50Hz (default) 09 50 Hz	60Hz 09 60 Hz
10	Output voltage	220V 10 220 ^v	230V(default) 10 230 ^v
		240V 10 240 ^v	
11	Maximum utility charging current Note: If setting value in program 02 is smaller than that in program in 11, the inverter will apply charging current from program 02 for utility charger.	30A(default) 11 30A	setting range is 2A,10A to 80A, the increment or decrement is 10A per click.
12	Setting voltage point back to utility source when selecting "battery priority" or "solar priority" in program 01.	11.5V(default) 12 BATT 11.5 ^v	Setting voltage point back 12V model:(default 11.5Vdc) setting range :10.5V to 15V setting increase or decrease of 0.5V.

		23.0V(default) 12 ^{BATT} 230 ^v	Setting voltage point back 24V model:(default 23.0Vdc) setting range :22V to 25.5V setting increase or decrease of 0.5V.
13	Setting voltage point back to battery mode when selecting “battery priority” or” solar priority” in program 01.	13.5V(default) 13 ^{BATT} 135 ^v	Setting voltage point back 12V model:(default 13.5Vdc) setting range :12.0V to 17V setting increase or decrease of 0.5V.
		27.0V(default) 13 ^{BATT} 270 ^v	Setting voltage point back 24V model:(default 27.0Vdc) setting range :24.0V to 29V setting increase or decrease of 0.5V.
		Battery fully charged 13 ^{BATT} FUL	
16	Charger source priority: To configure charger source priority	If this inverter/charger is working in Line, Standby or Fault mode, charger source can be programmed as below:	
		Utility first 16 CUT	Utility will charge battery as first priority. Solar energy will charge battery only when utility power is not available.
		Solar first 16 CSO	Solar energy will charge battery as first priority. Utility will charge battery only when solar energy is not available.
		Solar and Utility (default) 16 SNU	Solar energy and utility will charge battery at the same time.
		Only Solar 16 OSO	Solar energy will be the only charger source no matter utility is available or not.
		If this inverter/charger is working in Battery mode or Power saving mode, only solar energy can charge battery. Solar energy will charge battery if it's available and sufficient.	
18	Alarm control	Alarm on (default) 18 60N	Alarm off 18 60F
19	Auto return to default display screen	Return to default display screen (default) 19 ESP	If selected, no matter how users switch display screen, it will automatically return to default display screen (Input voltage /output voltage) after no button is pressed for 1 minute.

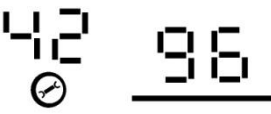
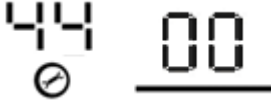
		Stay at latest screen 19 FEB	If selected, the display screen will stay at latest screen user finally switches.
20	Backlight control	Backlight on (default) 20 LON	Backlight off 20 LOF
22	Beeps while primary source is interrupted	Alarm on (default) 22 AON	Alarm off 22 AOF
23	Overload bypass: When enabled, the unit will transfer to line mode if overload occurs in battery mode.	Bypass disable (default) 23 byd	Bypass enable 23 byE
25	Record Fault code	Record enable (default) 25 FEN	Record disable 25 FdS
26	Bulk charging voltage (C.V voltage)	default : 14.1V CU 26 BATT 14.1V	Setting voltage point back 12V model:(default 14.1Vdc) setting range :12.5V to 15.5V setting increase or decrease of 0.5V.
		default : 28.2V CU 26 BATT 28.2V	Setting voltage point back 24V model:(default 28.2Vdc) setting range :25V to 31.5V setting increase or decrease of 0.5V.
27	Floating charging voltage	default: 13.5V FLU 27 BATT 13.5V	Setting voltage point back 12V model:(default 13.5Vdc) setting range :12.5V to 15.5V setting increase or decrease of 0.5V.
		default: 27.0V FLU 27 BATT 27.0V	Setting voltage point back 24V model:(default 27.0Vdc) setting range :25V to 31.5V setting increase or decrease of 0.5V.
29	Low DC cut-off voltage	default : 10.5V COU 29 BATT 10.5V	Setting voltage point back 12V model:(default 10.5Vdc) setting range :10.0V to 12.0V setting increase or decrease of 0.5V.
		default : 21.0V COU 29 BATT 21.0V	Setting voltage point back 24V model:(default 21.0Vdc) setting range :21.0V to 24.0V setting increase or decrease of 0.5V.



30	Battery equalization	Battery equalization 30 EEN	Battery equalization disable (default) 30 EdS
		If "Flooded" or "User-Defined" is selected in program 05, this program can be set up.	
31	Battery equalization voltage	default : 14.6V 31 31 14.6 ^v	Setting voltage point back 12V model:(default 14.6Vdc) setting range :13.0V to 15.0V setting increase or decrease of 0.5V.
		default : 29.2V 31 31 29.2 ^v	Setting voltage point back 24V model:(default 29.2Vdc) setting range :25V to 31.5V setting increase or decrease of 0.5V.
33	Battery equalized time	60min (default) 33 60	Setting range is from 5min to 900min. Increment of each click is 5min.
34	Battery equalized timeout	120min (default) 34 120	Setting range is from 5min to 900min. Increment of each click is 5min.
35	Equalization interval	30days (default) 35 30d	Setting range is from 0 to 90 days. Increment of each click is 1 day
36	Equalization activated immediately	Enable 36 AEN	Disable (default) 36 AdS
		If equalization function is enabled in program 30, this program can be set up. If "Enable" is selected in this program, it's to activate battery equalization immediately and LCD main page will shows "EQ". If "Disable" is selected, it will cancel equalization function until next activated equalization time arrives based on program 35 setting. At this time, "EQ" will not be shown in LCD main page.	
40	Discharge limited current	40 OFF	OFF: default ; discharge current limited disable
		40 10 ^A	setting range :10A to 200A setting increase or decrease of 5A. NOTE: 1. if you work in "solar priority" or "battery priority mode", when the loads is greater than the current limiting point, it will automatically switch to utility mode. 2.if it only works in battery mode, when the load is greater than the current limiting point, the inverter

41	Lithium battery "SOC" discharge stop		<p>Default:6%</p> <p>1.When the battery capacity of the lithium battery is lower than the set point, the inverter stops discharging and output will be turned off. setting range :1% to 60% setting increase or decrease of 1%.</p> <p>2.when the communication connection between the lithium battery and the inverter is normal, "USER" will be displayed next to the battery icon on ten display</p>
42	Lithium battery "SOC" charge stop		<p>Default:96%</p> <p>1.When the battery capacity of the lithium battery is higher than the set point, the inverter stops charging setting range :61% to 100% setting increase or decrease of 1%.</p> <p>2.when the communication connection between the lithium battery and the inverter is normal, "USER" will be displayed next to the battery icon on ten display screen</p>
44	Reconnection delay time		<p>When the utility is connected, the waiting time can be set. After reaching the waiting time, the utility will start working. Range:0-999S</p>
50	Battery activation	<p>Activation activation (default)</p> 	<p>Activation activation: When the AC is connected to the inverter and turned it on. And if the battery cannot be detected, the battery will be activated. (If it fails, disconnect AC and restart)</p>
		<p>ON</p> 	<p>Manual activation : In this mode, select "On", connect the AC or PV to the inverter, and turn it on. If the battery is not detected, an activation of the battery is performed. "Off" will be returned if activation is successful or fail</p>
		<p>OFF</p> 	

4.5 Display Setting



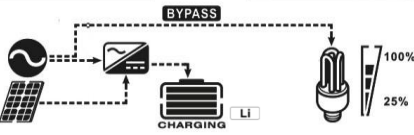
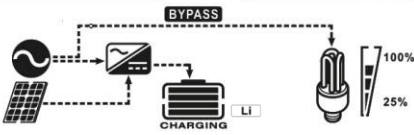
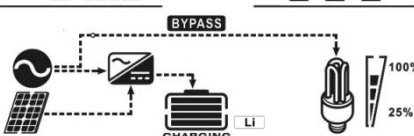
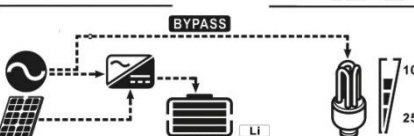
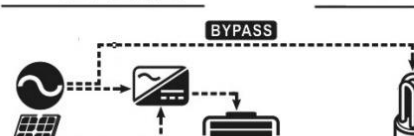



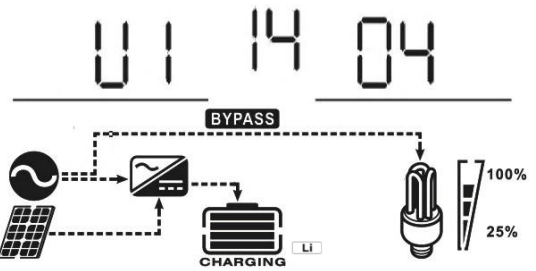
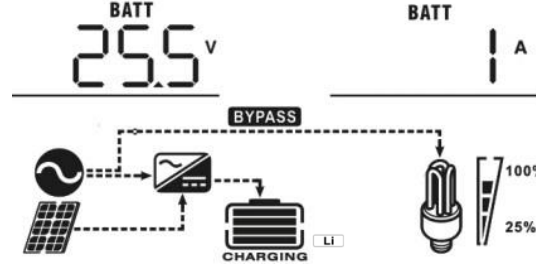
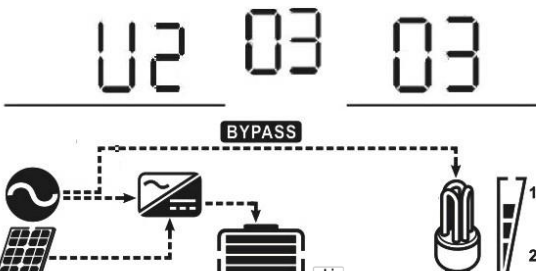

The LCD display information will be switched in turns by pressing “UP” or “DOWN” key. The selectable information is switched as below order: input voltage, input frequency, PV voltage, charging current, charging power (only for MPPT models), battery voltage, output voltage, output frequency, load percentage, load in Watt, load in VA, load in Watt, DC discharging current, main CPU Version and second CPU Version.

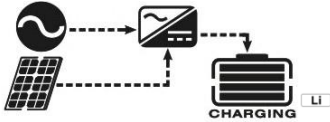
Selectable information	LCD display
Input voltage/Output voltage (Default Display Screen)	<p>Input Voltage=230V, output voltage=230V</p>
Input frequency	<p>Input frequency=50Hz</p>
PV voltage	<p>PV voltage=60V</p>
Charging current	<p>Charging current=50A</p>
Charging power (only for MPPT model)	<p>MPPT charging power=500W</p>
Battery voltage and output voltage	<p>Battery voltage=25.5V, output voltage=230V</p>

Output frequency	<p>Output frequency=50Hz</p> <p>BATT 25.5 v OUTPUT 50.0 Hz</p> 
Load percentage	<p>Load percent=70%</p> <p>BATT 25.5 v LOAD 70 %</p> 
Load in VA	<p>When connected load is lower than 1kVA, load in VA will present xxxVA like below chart.</p> <p>BATT 25.5 v LOAD 350 VA</p>  <p>When load is larger than 1kVA ($\geq 1\text{kVA}$), load in VA will present x.xkVA like below chart.</p> <p>BATT 25.5 v LOAD 150 kVA</p> 
Load in Watt	<p>When load is lower than 1kW, load in W will present xxxW like below chart.</p> <p>BATT 25.5 v LOAD 270 W</p>  <p>When load is larger than 1kW ($\geq 1\text{kW}$), load in W will present x.xkW like below chart.</p> <p>BATT 25.5 v LOAD 120 kW</p> 

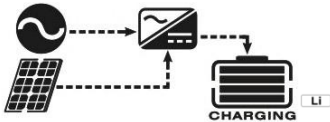
<p>Battery voltage/DC discharging current</p>	<p>Battery voltage=25.5V, discharging current=1A</p>  <p>The LCD display shows 'U1 14 04'. Below it is a system diagram showing a solar panel, a battery, and a load. A 'BYPASS' label is positioned above the load. The battery is labeled 'CHARGING' and 'Li'. To the right, a light bulb is shown with a meter indicating 100% and 25%.</p>
<p>Main CPU version checking</p>	<p>Main CPU version 00014.04</p>  <p>The LCD display shows 'BATT 25.5 V' and 'BATT 1 A'. Below it is a system diagram identical to the first row, showing a solar panel, a battery, and a load. A 'BYPASS' label is positioned above the load. The battery is labeled 'CHARGING' and 'Li'. To the right, a light bulb is shown with a meter indicating 100% and 25%.</p>
<p>Secondary CPU version checking</p>	<p>Secondary CPU version 00003.03</p>  <p>The LCD display shows 'U2 03 03'. Below it is a system diagram identical to the first row, showing a solar panel, a battery, and a load. A 'BYPASS' label is positioned above the load. The battery is labeled 'CHARGING' and 'Li'. To the right, a light bulb is shown with a meter indicating 100% and 25%.</p>

4.6 Operating Mode Description

Operation mode	Description	LCD display
<p>Standby mode / Power saving mode</p> <p>Note:</p> <p>*Standby mode: The inverter is not turned on yet but at this time, the inverter can charge battery without AC output.</p> <p>*Power saving mode: If enabled, the output of inverter will be off when connected load is pretty low or not detected.</p>	<p>No output is supplied by the unit but it still can charge batteries.</p>	<p>Charging by utility and PV energy.</p> 
		<p>Charging by utility.</p> 
		<p>Charging by PV energy.</p> 
		<p>No charging.</p> 
<p>Fault mode</p> <p>Note:</p> <p>*Fault mode: Errors are caused by inside circuit error or external reasons such as over temperature, output short circuited and so on.</p>	<p>PV energy and utility can charge batteries.</p>	<p>Charging by utility and PV energy.</p> 
		<p>Charging by utility.</p> 
		<p>Charging by PV energy.</p> 
		<p>No charging.</p> 

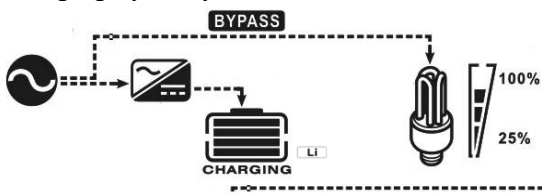
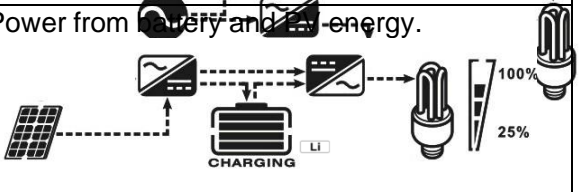
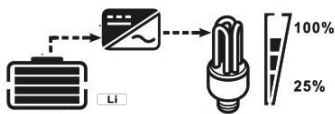
Operation mode	Description	LCD display
Line Mode	The unit will provide output power from the mains. It will also charge the battery at line mode.	Charging by utility and PV energy. 
		Charging by utility. 
Battery Mode	The unit will provide output power from battery and PV power.	Power from battery and PV energy. 
		Power from battery only. 

4.7 Battery Equalization Description

Equalization function is added into charge controller. It reverses the buildup of negative chemical effects like stratification, a condition where acid concentration is greater at the bottom of the battery than at the top. Equalization also helps to remove sulfate crystals that might have built up on the plates. If left unchecked, this condition, called sulfating, will reduce the overall capacity of the battery. Therefore, it's recommended to equalize battery periodically.

● How to Apply Equalization Function

You must enable battery equalization function in monitoring LCD setting program 30 first. Then, you may apply this function in device by either one of following methods:

1. Setting equalization interval in program 35.
2. Active equalization immediately in program 36.

● When to Equalize

In float stage, when the setting equalization interval (battery equalization cycle) is arrived, or equalization is active immediately, the controller will start to enter Equalize stage.

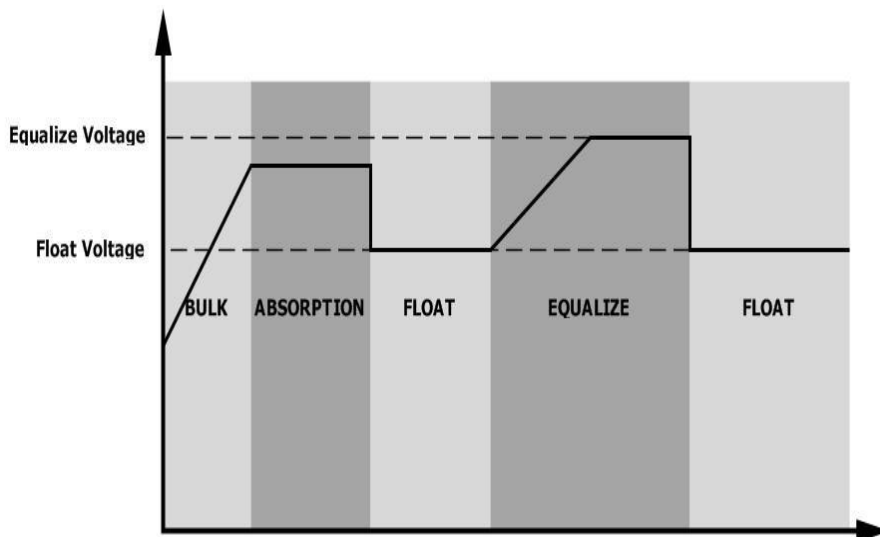

● **Equalize charging time and timeout**

In Equalize stage, the controller will supply power to charge battery as much as possible until battery voltage raises to battery equalization voltage. Then, constant-voltage regulation is applied to maintain battery voltage at the battery equalization voltage. The battery will remain in the Equalize stage until setting battery equalized time is arrived.

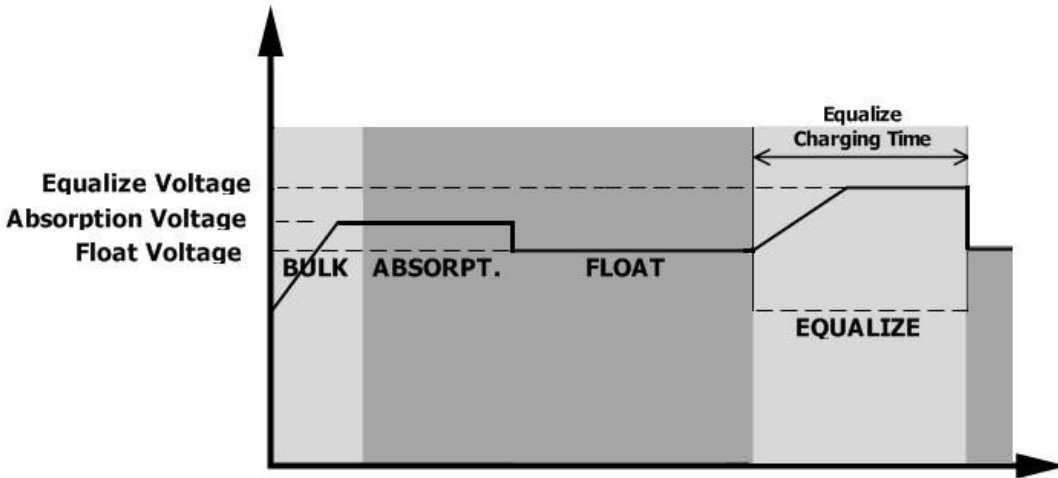

However, in Equalize stage, when battery equalized time is expired and battery voltage doesn't rise to battery equalization voltage point, the charge controller will extend the battery equalized time until battery voltage achieves battery equalization voltage. If battery voltage is still lower than battery equalization voltage when battery equalized timeout setting is over, the charge controller will stop equalization and return to float stage.

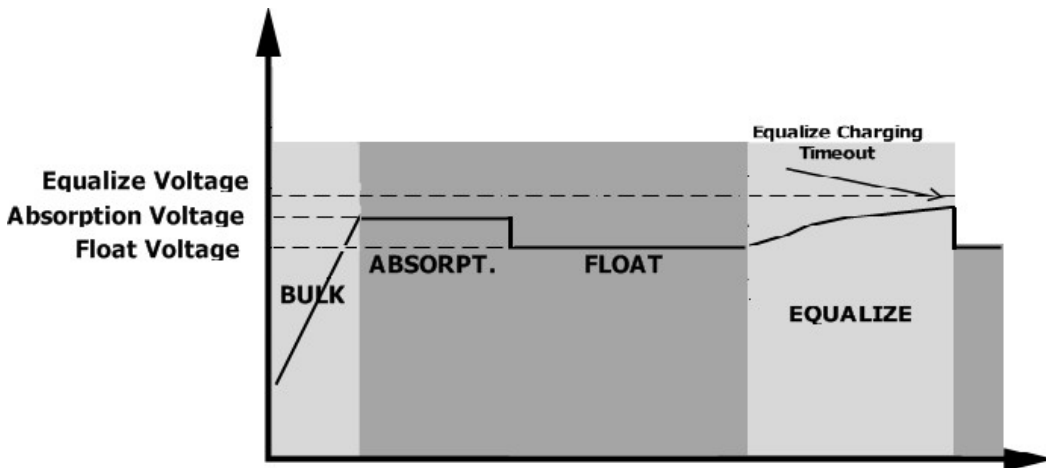

5. Fault Reference Code

Fault Code	Fault Event
01	Fan is locked when inverter is off.
02	Over temperature
03	Battery voltage is too high
04	Battery voltage is too low
05	Output short circuited or over temperature is detected by internal converter components.
06	Output voltage is too high.
07	Overload time out
08	Bus voltage is too high
09	Bus soft start failed
51	Over current or surge
52	Bus voltage is too low
53	Inverter soft start failed
55	Over DC voltage in AC output
57	Current sensor failed
58	Output voltage is too low
59	PV voltage is over limitation

6. Warning Indicator

Warning Code	Warning Event
01	Fan is locked when inverter is on.
02	Over temperature
03	Battery is over-charged
04	Low battery
07	Overload
08	Discharge current limiting
10	Output power derating
15	PV energy is low
16	High AC input (>280VAC) during BUS soft start
89	Battery equalization
6P	Battery is not connected

7. Trouble Shooting

Problem	LCD/LED/Buzzer	Explanation / Possible cause	What to do
Unit shuts down automatically during startup process.	LCD/LEDs and buzzer will be active for 3 seconds and then complete off.	The battery voltage is too low (<1.91V/Cell)	1. Re-charge battery. 2. Replace battery.
No response after power on.	No indication.	1. The battery voltage is far too low. (<1.4V/Cell) 2. Internal fuse tripped.	1. Contact repair center for replacing the fuse. 2. Re-charge battery. 3. Replace battery.
Mains exist but the unit works in battery mode.	Input voltage is displayed as 0 on the LCD and green LED is flashing.	Input protector is tripped	Check if AC breaker is tripped and AC wiring is connected well.
	Green LED is flashing.	Insufficient quality of AC power. (Shore or Generator)	1. Check if AC wires are too thin and/or too long. 2. Check if generator (if applied) is working well or if input voltage range setting is correct.
	Green LED is flashing.	Set "SUB" (solar first) as the priority of output source.	Change output source priority to "USB" (utility first).
When the unit is turned on, internal relay is switched on and off repeatedly.	LCD display and LEDs are flashing	Battery is disconnected.	Check if battery wires are connected well.
Buzzer beeps continuously and red LED is on.	Fault code 07	Overload error. The inverter is overload 110% and time is up.	Reduce the connected load by switching off some equipment.
		If PV input voltage is higher than specification, the output power will be derate. At this time, if connected loads is higher than derate output power, it will cause overload.	Reduce the number of PV modules in series or the connected load.
	Fault code 05	Output short circuited.	Check if wiring is connected well and remove abnormal load.
		Temperature of internal converter component is over 120°C.	Check whether the air flow of the unit is blocked or whether the ambient temperature is too high.
Fault code 02	Internal temperature of inverter component is over 100°C.		

Buzzer beeps continuously and red LED is on.	Fault code 03	Battery is over-charged.	Return to repair center.
		The battery voltage is too high.	Check if spec and quantity of batteries are meet requirements.
	Fault code 01	Fan fault	Replace the fan.
	Fault code 06/58	Output abnormal (Inverter voltage below than 190Vac or is higher than 260Vac)	1. Reduce the connected load. 2. Return to repair center
	Fault code 08/09/53/57	Internal components failed.	Return to repair center.
	Fault code 51	Over current or surge.	Restart the unit, if the error happens again, please return to repair center
	Fault code 52	Bus voltage is too low.	
	Fault code 55	Output voltage is unbalanced	
	Fault code 59	PV input voltage is beyond the specification.	Reduce the number of PV modules in series.

8. Line Mode Specification

INVERTER MODEL	1.6K12Vdc	3.2K24Vdc
Input Voltage Waveform	Sinusoidal (utility or generator)	
Nominal Input Voltage	230Vac	
Low Loss Voltage	170Vac \pm 7V (narrow range) 90Vac \pm 7V (wide range)	
Low Loss Return Voltage	180Vac \pm 7V (narrow range) 100Vac \pm 7V (wide range)	
High Loss Voltage	280Vac \pm 7V	
High Loss Return Voltage	270Vac \pm 7V	
Max AC Input Voltage	300Vac	
Nominal Input Frequency	50Hz / 60Hz (Auto detection)	
Low Loss Frequency	40 \pm 1Hz	
Low Loss Return Frequency	42 \pm 1Hz	
High Loss Frequency	65 \pm 1Hz	
High Loss Return Frequency	63 \pm 1Hz	
Output Short Circuit Protection	Circuit Breaker	
Efficiency (Line Mode)	>95% (Rated R load, battery full charged)	
Transfer Time	10ms typical (narrow range),20ms typical (wide range)	
Output power derating: When AC input voltage drops to 170V, the output power will be derated.	<p>The graph plots Output Power on the vertical axis against Input Voltage on the horizontal axis. The horizontal axis has markers at 90V, 170V, and 280V. The vertical axis has markers for 50% Power and Rated Power. The power curve starts at zero, jumps to 50% power at 90V, then rises linearly to reach Rated Power at 170V. From 170V to 280V, the power remains constant at the Rated Power level. After 280V, the power drops to zero.</p>	

9. Inverter Mode Specification

INVERTER MODEL	1.6K12Vdc	3.2K24Vdc
Rated Output Power	1600VA/1600W	3200VA/3200W
Output Voltage Waveform	Pure Sine Wave	
Output Voltage Regulation	230Vac±5%	
Output Frequency	50Hz/60Hz	
Peak Efficiency	91%	
Overload Protection	10s@110%~130% load , 5s@130%~200% load, 200ms@≥200% load	
Surge Capacity	2* rated power for 5 seconds	
Cold Start Voltage	11.5Vdc	23.0Vdc
Low DC Warning Voltage @ load < 50%	11.0Vdc	22.0Vdc
@ load ≥ 50%	10.5Vdc	21.0Vdc
Low DC Warning Return Voltage @ load < 50%	11.5Vdc	22.5Vdc
@ load ≥ 50%	11.0Vdc	22.0Vdc
Low DC Cut-off Voltage @ load < 50%	10.2Vdc	20.5Vdc
@ load ≥ 50%	9.6Vdc	20.0Vdc
High DC Recovery Voltage	14.0Vdc	32.0Vdc
High DC Cut-off Voltage	16.0Vdc	33.0Vdc

10. Charge Mode Specification

INVERTER MODEL		1.6K12Vdc	3.2K24Vdc
Charging Algorithm		3-Step	
Utility Charging Mode			
AC Charging Current		2/10/20/30/40/50/60/70/80Amp (@V _{IP} =230Vac)	
Bulk Charging Voltage	Flooded Battery	14.6Vdc	29.2Vdc
	AGM / Gel Battery	14.1Vdc	28.2Vdc
Floating Charging Voltage		13.5Vdc	27.0Vdc
Charging Curve		<p>The graph plots Battery Voltage (per cell) on the left y-axis and Charging Current (%) on the right y-axis against Time on the x-axis. The voltage curve (black) rises linearly in the Bulk stage, plateaus in the Absorption stage, and then slightly drops and remains constant in the Maintenance stage. The current curve (red) is constant at 100% in the Bulk stage, then decays exponentially in the Absorption stage, and finally drops to 0% in the Maintenance stage. Key voltage points are 2.43Vdc (2.35Vdc) and 2.25Vdc. Time intervals T0 and T1 are marked, with T1 = 10 * T0, minimum 10 mins, maximum 10 hrs.</p>	
Max. charging current(Solar+AC)		100A	

11. Solar Mode Specifications

MODEL	1.6K12Vdc	3.2K24Vdc
Rate output voltage	230VAC	
Output voltage range	230 ± 5%VAC	
PV Input Max. Power	2000W	3500W
PV Array MPPT Voltage Range	60-450VDC	
Start-up Voltage	70Vdc +/- 5Vdc	
Nominal PV Voltage	260Vdc	
Max. PV Array Open Circuit Voltage	500Vdc	
Max. PV input current	12A	15A

12.General Specifications

INVERTER MODEL	1.6K12Vdc	3.2K24Vdc
Safety Certification	CE	
Operating Temperature Range	-10°C to 50°C	
Storage temperature	-15°C ~ 60°C	
Humidity	5% to 95% Relative Humidity (Non-condensing)	
Dimension (L*W*H), mm	348X254X105	
Net Weight (KG)	5	5.5
Gross Weight (KG)	6.5	7

13. Installation Dimension Drawing

Unit: mm

NOTE: the following picture is only a schematic diagram of the equipment .If the actual chassis does not conform to the schematic due to a structural upgrade it is subject to prior notice.

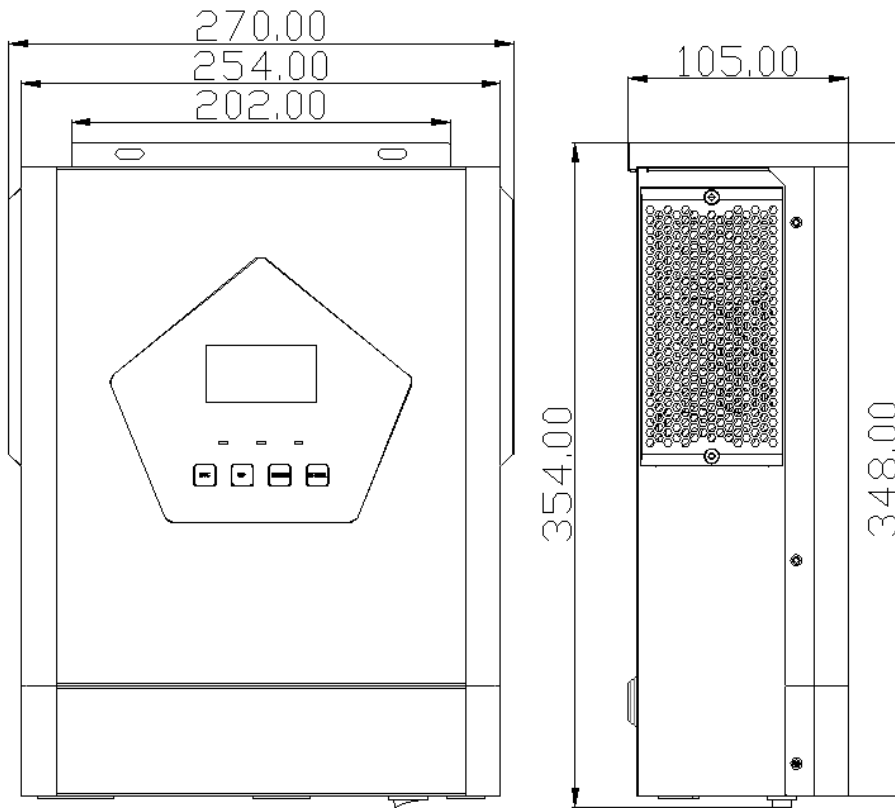

614.C05705-00