



## SOL1 ULTRA TWIN INVETER 4KW/6KW

### USER MANUAL



Model No: EM-6048TW S1 ULTRA  
EM-4024TW S1 ULTRA

# Table Of Contents

1. About This Manual .....	1
1.1 Purpose .....	1
1.2 Scope .....	1
2. Safety Instructions .....	1
3. Introduction .....	1
3.1 Features .....	1
3.2 Basic System Architecture .....	2
3.3 Product Overview .....	3
RS232 .....	3
1:RXD, 2:TXD , 8:GND .....	3
CAN .....	3
RS485 .....	3
4: CAN-H , 5: CAN-L .....	3
4. Installation .....	4
4.1 Unpacking and Inspection .....	4
4.2 Preparation .....	4
4.3 Mounting the Unit .....	4
4.4 Battery Connection .....	5
4.5 AC Input/output Connection .....	7
4.6 PV Connection .....	8
4.7 Dry Contact Signal .....	10
4.8 Wi-Fi Connection(Optional) .....	10
4.9 Bluetooth Communication (Optional) .....	10
5. Operation .....	11
5.1 Operation and Display Panel .....	11
5.2 LCD Display Icons .....	12
5.3 LCD Setting .....	16
5.4 Battery Equalization Description .....	25
5.5 Fault Reference Code .....	26
5.6 Warning Indicator .....	26
6. Specifications .....	27
Table 1 Line Mode Specifications .....	27
Table 2 Inverter Mode Specifications .....	28
Table 3 Charge Mode Specifications .....	29
Table 4 General Specifications .....	29
7. Trouble Shooting .....	30
8. Installation Dimension Drawing .....	31

# 1. About This Manual

## 1.1 Purpose

This manual describes the assembly, installation, operation and troubleshooting of this unit. Please read this manual carefully before installations and operations. Keep this manual for future reference.

## 1.2 Scope

This manual provides guidelines of safety installation as well as the information on tools and wiring.

## 2. Safety Instructions



**WARNING:** All safety instructions in this document must be read, understood and followed. Failure to follow these instructions will result in death or serious injury.

1. Before using the unit, read all instructions and cautionary markings on the unit, the batteries and all appropriate sections of this manual.
2. **CAUTION** --To reduce risk of injury, charge only deep-cycle type rechargeable batteries. Other types of batteries may burst, causing personal injury and damage.
3. Do not disassemble the unit. Take it to a qualified service center when service or repair is required. Incorrect re-assembly may result in a risk of electric shock or fire.
4. To reduce risk of electric shock, disconnect all wirings before attempting any maintenance or cleaning. Turning off the unit will not reduce this risk.
5. **CAUTION** – Only qualified personnel can install this device with battery.
6. **NEVER** charge a frozen battery.
7. For optimum operation of this inverter/charger, please follow required spec to select appropriate cable size. It's very important to correctly operate this inverter/charger.
8. Be very cautious when working with metal tools on or around batteries. A potential risk exists to drop a tool to spark or short circuit batteries or other electrical parts and could cause an explosion.
9. Please strictly follow installation procedure when you want to disconnect AC or DC terminals. Please refer to **INSTALLATION** section of this manual for the details.
10. One piece of 200A fuse is provided as over-current protection for the battery supply.
11. **GROUNDING INSTRUCTIONS** -This inverter/charger should be connected to a permanent grounded wiring system. Be sure to comply with local requirements and regulation to install this inverter.
12. **NEVER** cause AC output and DC input short circuited. Do **NOT** connect to the mains when DC input short circuits.
13. **Warning!!** Only qualified service persons are able to service this device. If errors still persist after following troubleshooting table, please send this inverter/charger back to local dealer or service center for maintenance.
14. **WARNING:** Because this inverter is non-isolated, only three types of PV modules are acceptable: single crystalline, poly crystalline with class A-rated and CIGS modules. To avoid any malfunction, do not connect any PV modules with possible current leakage to the inverter. For example, grounded PV modules will cause current leakage to the inverter. When using CIGS modules, please be sure **NO** grounding.
15. **CAUTION:** It's requested to use PV junction box with surge protection. Otherwise, it will cause damage on inverter when lightning occurs on PV modules.

## 3. Introduction

This is a multi-function inverter, combining functions of inverter, solar charger and battery charger to offer uninterruptible power support in a single package. The comprehensive LCD display offers user-configurable and easy-accessible button operations such as battery charging current, AC or solar charging priority, and acceptable input voltage based on different applications.

### 3.1 Features

1. Pure sine wave inverter
2. Configurable input voltage ranges for home appliances and personal computers via LCD control panel
3. Configurable battery charging current based on applications via LCD control panel
4. Configurable AC/Solar Charger priority via LCD control panel
5. Compatible to utility mains or generator power
6. Auto restart while AC is recovering
7. Overload / Over temperature / short circuit protection
8. Smart battery charger design for optimized battery performance
9. Cold start function
10. Second output can be controlled by battery voltage

### 3.2 Basic System Architecture

The following illustration shows basic application for this unit. It also required the following devices to have a complete running system:

- Generator or Utility mains.
- PV modules

Consult with your system integrator for other possible system architectures depending on your requirements. This inverter can power various appliances in home or office environment, including motor-type appliances such as tube light, fan, refrigerator and air conditioners.

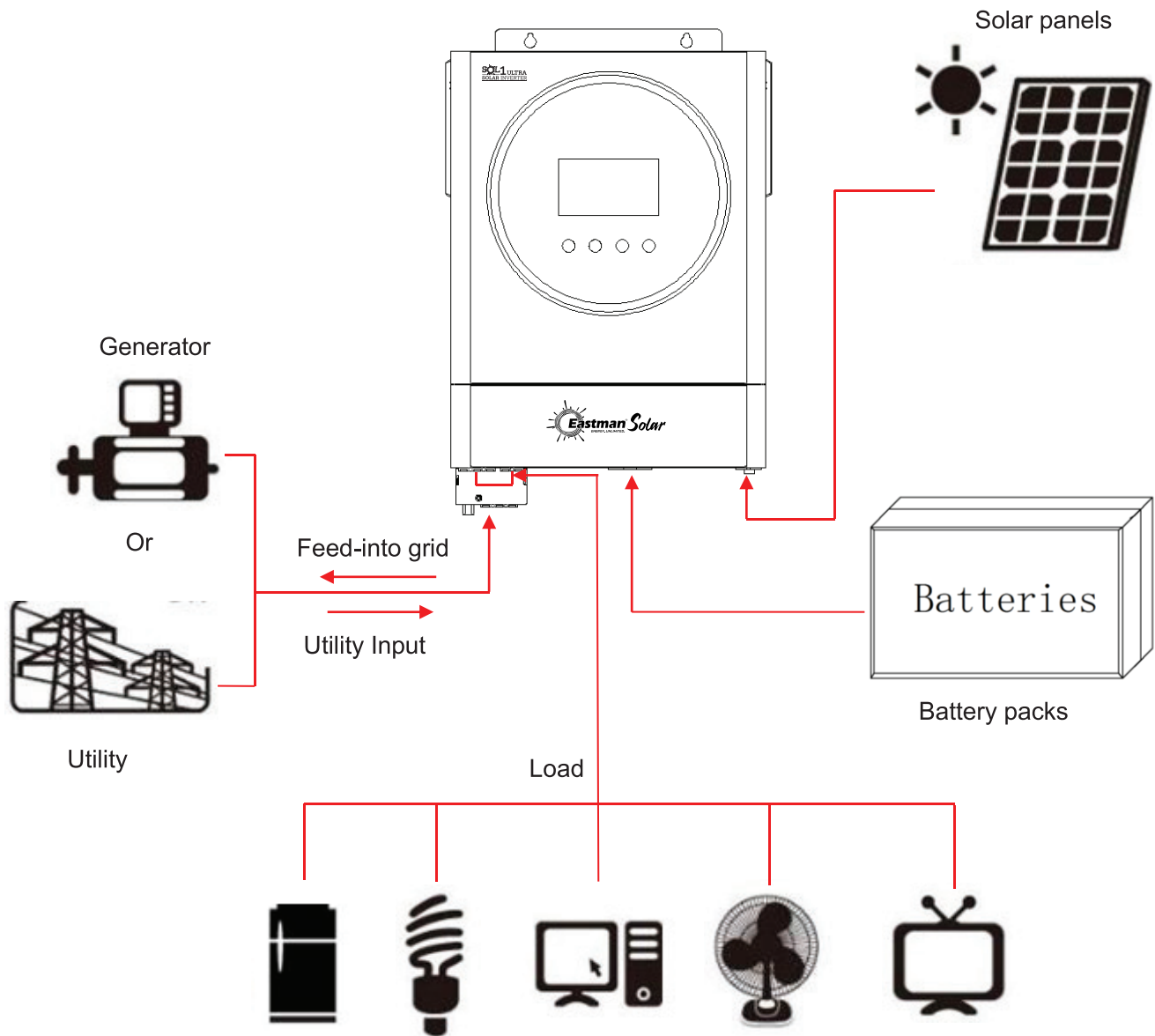

Figure 1 Hybrid Power System

### 3.3 Product Overview

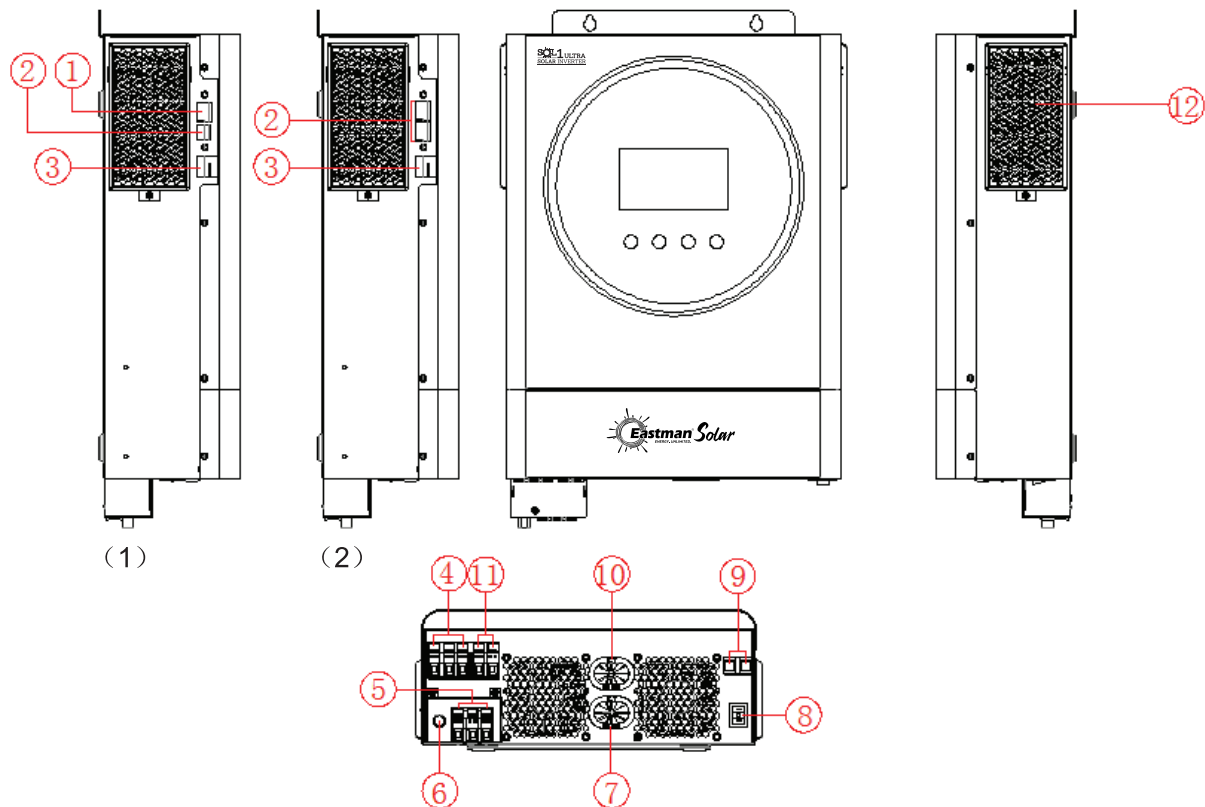
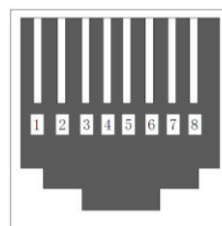

Figure 2:4K/6K model

1. RS-232/RS485/CAN Communication Port
2. USB Communication Port ( dual RJ45 communication Port is optional )
3. Dry Contact Connector
- 4.AC Output 1 Terminal
5. AC Input Terminal
6. AC Input Breaker
7. Battery Input 1
8. Power On/off Switch
9. PV Input Terminal
10. Battery Input 2
11. AC Output 2 Terminal
- 12.Dust Cover

#### Communication port definition ( 1 ) :

RS232	1:RXD , 2:TXD,8:GND
RS485	6:485-B ,7.485-A
CAN	3: CAN-H,5: CAN-L



RJ45 Port

#### Communication port definition ( 2 ) :

COMM: RS232	1:RXD, 2:TXD , 8:GND
BMS: CAN RS485	1:485B , 2: 485A 4: CAN-H , 5: CAN-L

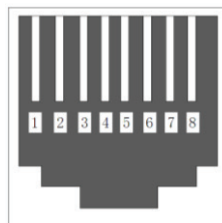

COMM

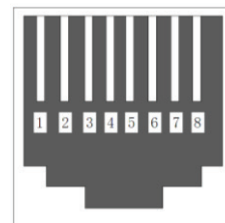

BMS

Figure 3: Dual RJ45 PORT

## 4. Installation

### 4.1 Unpacking and Inspection

Before installation, please inspect the content. Be sure that nothing inside the package is damaged. You should have received the following items inside the package:

- Inverter x 1
- User manual x 1
- Communication cable x 2

### 4.2 Preparation

Please remove the two screws on the bottom cover of the inverter as shown below before connecting all wirings.

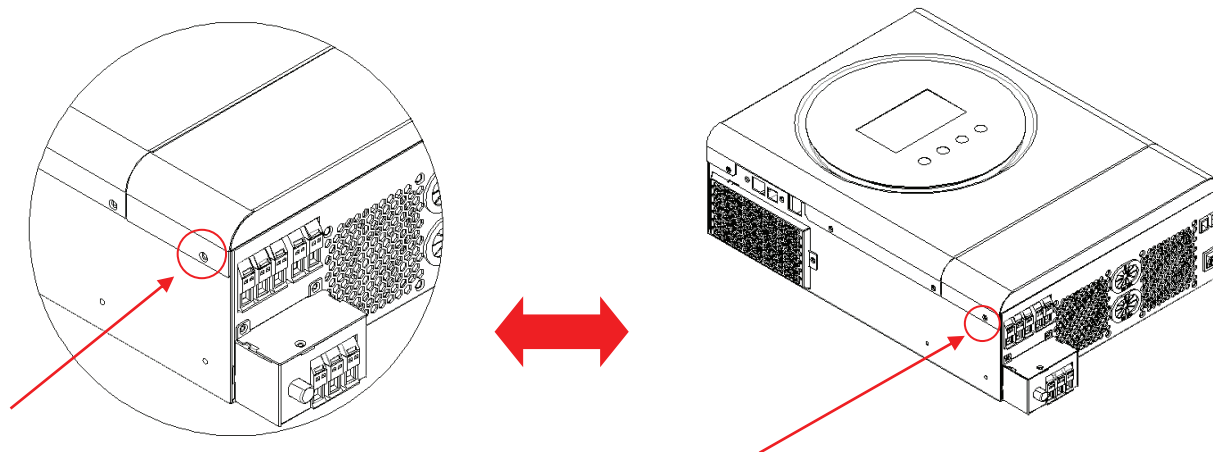

### 4.3 Mounting the Unit

Consider the followings before selecting your placements:

1. Do not mount the inverter on flammable construction materials.
2. Mount on a solid surface
3. Install the inverter at a visible place in order to the LCD display can be read easily.
4. For proper air circulation and heat dissipation, allow a clearance of approx.30 cm to the side and approx. 50 cm above and below the unit.
5. The ambient temperature should be between  $-10^{\circ}\text{C}$  and  $50^{\circ}\text{C}$  to ensure optimal operation.
6. The recommended orientation is to adhered to the wall vertically. Be sure to keep other objects and surfaces as shown in the diagram to guarantee sufficient heat dissipation and to have enough space for wirings.

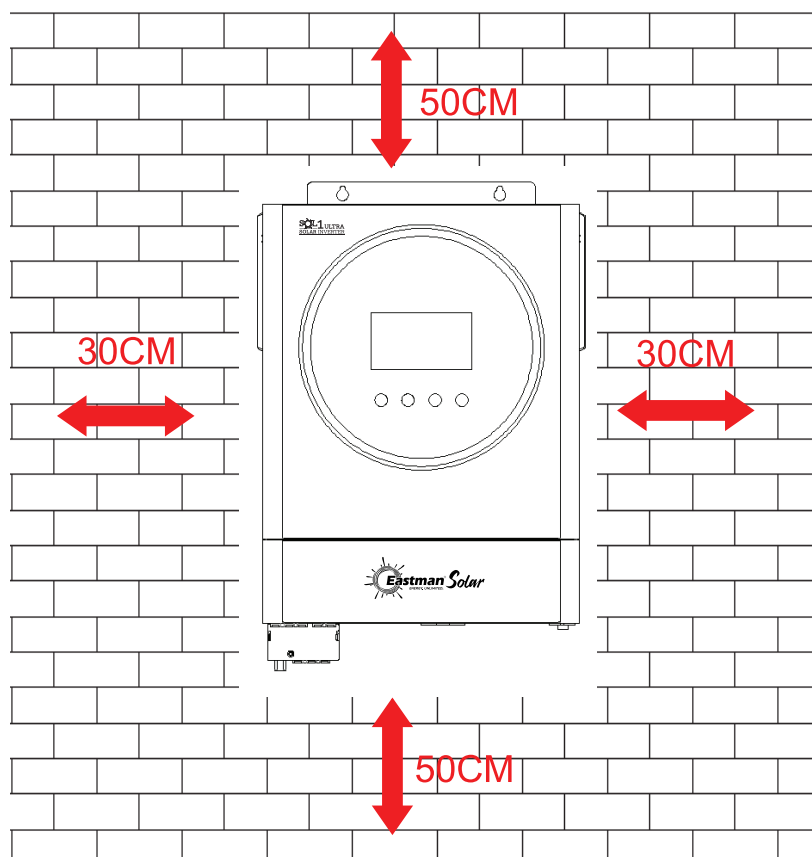

 **SUITABLE FOR MOUNTING ON CONCRETE OR OTHER NON-COMBUSTIBLE SURFACE ONLY**  
 Mounting the unit by screwing the three screws as shown below. It's recommended to use M4 or M5 screws.

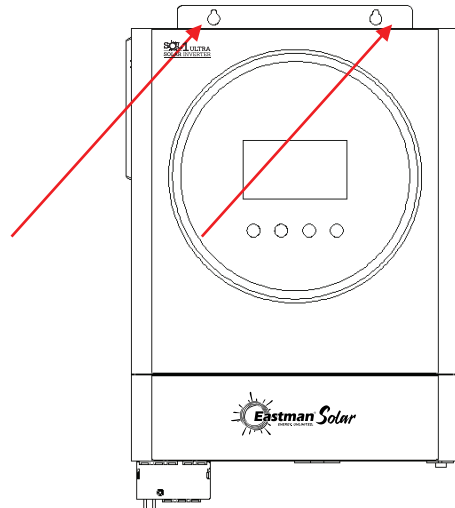

## 4.4 Battery Connection

**CAUTION:** For safety operation and regulation compliance, it's requested to install a separate DC over-current protector or disconnection device between battery and the inverter. It may not be necessary to have a disconnection device in some applications, however, it's still recommended to have over-current protection installed. Please refer to typical amperage as required.

**WARNING!** All wiring must be performed by a qualified electrical technician. **WARNING!** It's very important for system safety and efficient operation to use appropriate cables for battery connection. To reduce risk of injury, please use the proper recommended cable in the table below.

Recommended battery cable size:

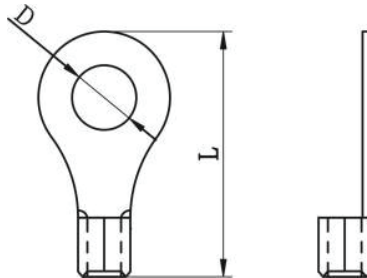

Ring terminal:

Model	Max. Discharge Current	AWG Cable	GB Cable mm <sup>2</sup>	Ring Terminal Dimensions		Torsion force value
				D(mm)	L(mm)	
4KW	190	2*4AWG	2*25 <sup>2</sup>	8.4	39.2	5Nm
6KW	143	1*3AWG	1*35 <sup>2</sup>			

Please take the following steps to implement battery connection:

1. Assemble the batteries according to the recommended battery cables and terminals. This cable applies only to the 4KW/6KW model.
2. Connect all battery packs as required. It is recommended that the 4K and 6K devices be connected to a battery with a capacity of at least 200AH.

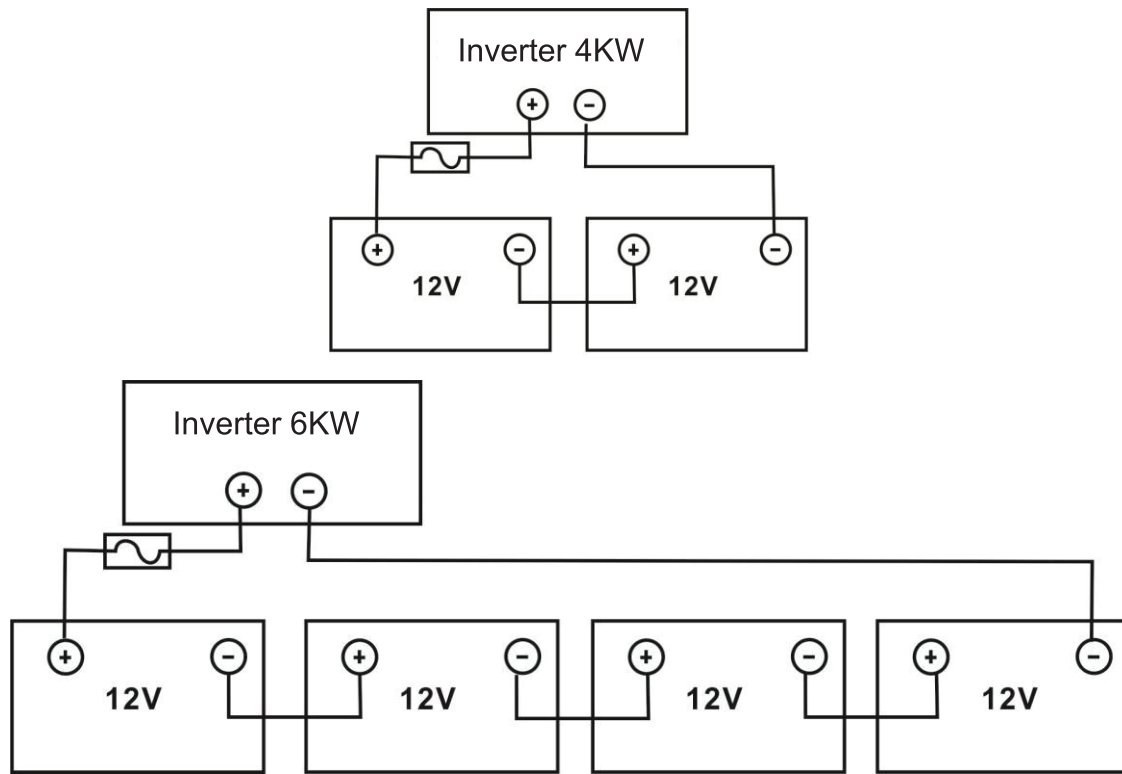

3. Connect the two wires to the proper screw terminal on the unit. For 4KW/6KW models, apply ring terminals to your battery wires and secure it to the battery terminal block with the bolts properly tightened. Refer to battery cable size for torque value. Make sure polarity at both the battery and the inverter is correctly connected and ring terminals are secured to the battery terminals.

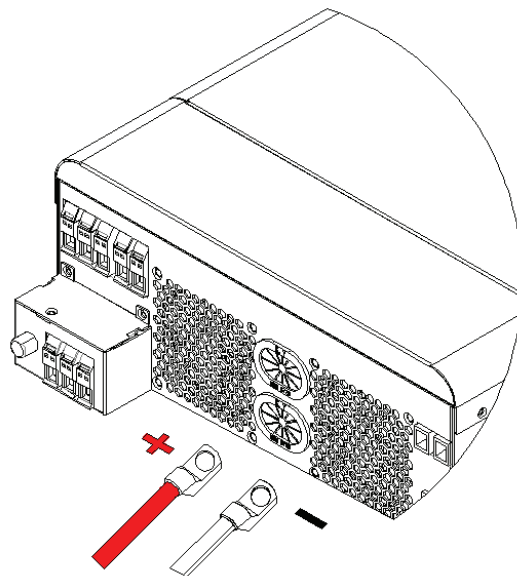

**WARNING: Shock Hazard**

Installation must be performed with care due to high battery voltage in series.

**CAUTION!!** Do not place anything between the flat part of the inverter terminal and the ring terminal. Otherwise, overheating may occur.

**CAUTION!!** Do not apply anti-oxidant substance on the terminals before terminals are connected tightly.

**CAUTION!!** Before making the final DC connection or closing DC breaker/disconnect or, be sure positive (+) must be connected to positive (+) and negative (-) must be connected to negative(-).



## 4.5 AC Input/output Connection

**CAUTION!!** Before connecting to AC input power source, please install a separate AC breaker between the inverter and the AC input power source. This will ensure that the inverter can be safely disconnected during maintenance and fully protected from over-current. The recommended spec of AC breaker 50A for 4KW and 63A for 6KW.

**CAUTION!!** There are two power terminal blocks with “IN” (Input) and “OUT” (Output) markings. DO NOT mistakenly connect to the wrong connectors.

**WARNING!** All wiring must be performed by a qualified personnel.

**WARNING!** It's very important for system safety and efficient operation to use appropriate cable size for AC input connection. To reduce risk of injury, please use the proper recommended cable size as below. Suggested cable requirement for AC wires.

Model	Gauge	Cable (mm <sup>2</sup> )	Torque Value
4KW	12AWG	4	1.2 Nm
6KW	10AWG	6	1.6Nm

Please follow these steps to implement AC input/output connection:

1. Before making AC input/output connection, please disconnect the AC protector first.
2. Remove insulation sleeves for about 10mm for the five screw terminals.
3. Insert AC input wires according to polarities indicated on terminal block and tighten the terminal screws. Be sure to connect the grounding wire (⊕) first.

⊕ → Ground (yellow-green)

L → LINE (brown or black) N → Neutral (blue)

**WARNING:**

Be sure that the AC power source is disconnected before attempting wire connections.

4. Insert AC output wires according to polarities indicated on terminal block and tighten terminal screws. Be sure to connect the grounding wire (⊕) first.

⊕ → Ground (yellow-green)

L → LINE (brown or black) N → Neutral (blue)

5. Make sure the wires are securely connected.

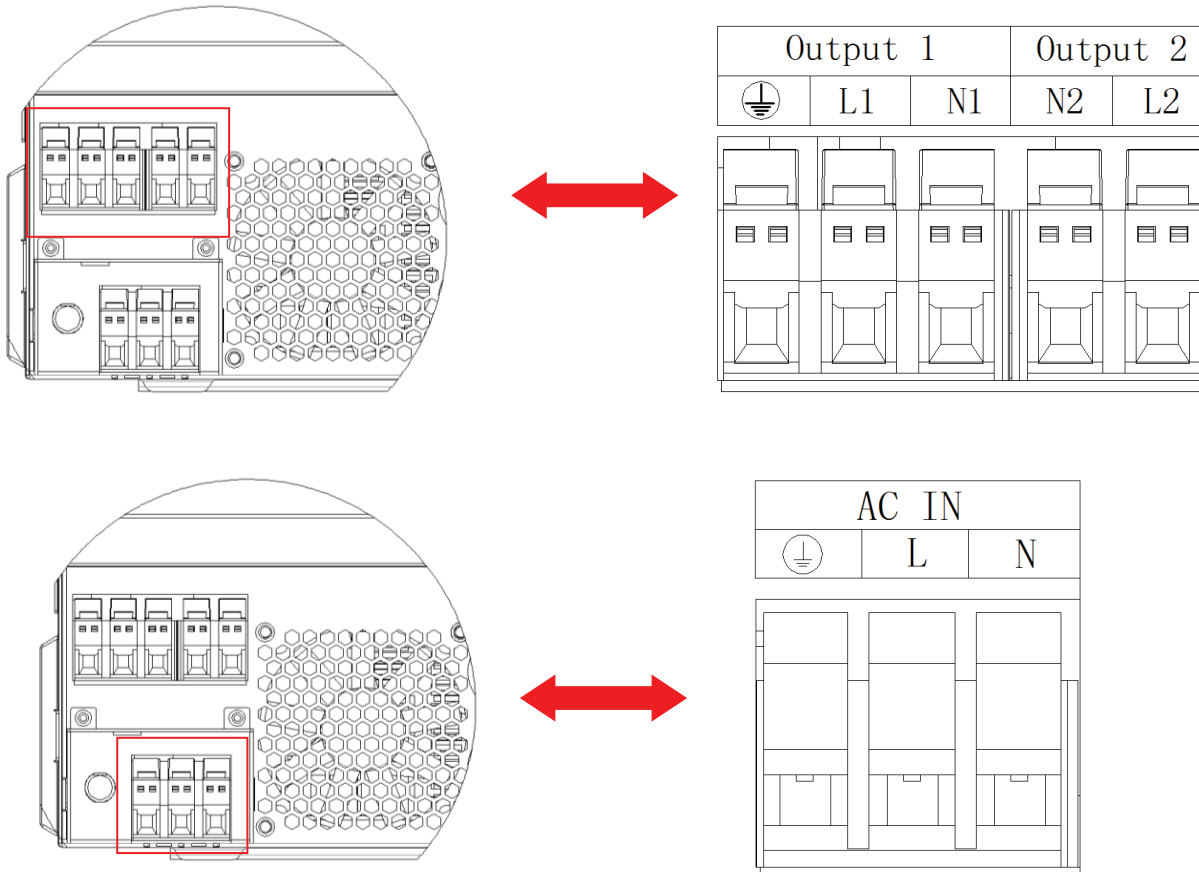

CAUTION: Appliances such as air conditioner required at least 2~3 minutes to spool up because it needs to have enough time to balance refrigerant gas inside of circuits. If a power shortage occurs and recovers in a short period of time, it may cause damage to your connected appliances. To prevent this from happening, please check with manufacturer of air conditioner if it has time-delay function before installation. Otherwise, this inverter will trigger overload fault and cut off output to protect your appliance but sometimes it may still causes damage to the air conditioner.

## 4.6 PV Connection

CAUTION: Before connecting to PV modules, please install a separately DC circuit breaker between the inverter and PV modules.

CAUTION: It is forbidden for inverters to share the same solar panel group.

WARNING! It's very important for system safety and efficient operation to use appropriate cable for PV module connection. To reduce risk of injury, please use the proper recommended cable size shown below.

Model	AWG Wire Size	GB Cable (mm2)	Torque Value (max.)
4KW/6KW	1 x 12AWG	4	1.2 Nm

WARNING: Because this inverter is non-isolated, are accepted: single crystalline, poly crystalline with class A-rated and CIGS modules. To avoid any malfunctions, do not connect any PV modules with possible current leakage to the inverter. For example, grounded PV modules will cause current leakage to the inverter. When using CIGS modules, please be sure NO grounding connection.

CAUTION: It's requested to use PV junction box with surge protection. Otherwise, it will cause damage on inverter when lightning occurs on PV modules.

PV Module Selection:

When selecting proper PV modules, please be sure to consider the following parameters:

1. Open circuit Voltage (Voc) of PV modules not to exceeds maximum PV array open circuit voltage of the inverter.
2. Open circuit Voltage (Voc) of PV modules should be higher than the start-up voltage.

Inverter Model	4KW	6KW
Max. PV Array Power	5000W	6000W
Max. PV Array Open Circuit Voltage	500Vdc	
PV Array MPPT Voltage Range	60Vdc~450Vdc	
Start-up Voltage	70Vdc±10Vdc	
Max. PV Input Current	27A	

Take the 250Wp PV module as an example. After considering above two parameters, the recommended module configurations are listed in the table below.

Solar Panel Spec. (reference) - 250Wp - Vmp: 30.0Vdc - Imp: 8.3A - Voc: 36.0Vdc - Isc: 8.4A	SOLAR INPUT	Q'ty of panels	Total input power
	Min. in serial: 2 pcs , max. in serial: 12 pcs		
	2 pcs in serial	2 pcs	600W
	4 pcs in serial	4 pcs	1000W
	6 pcs in serial	6 pcs	1500W
	8 pcs in serial	8 pcs	2000W
	10 pcs in serial	10 pcs	2500W
	12 pcs in serial	12 pcs	3000W
	8 pieces in serial and 2 sets in parallel	16 pcs	4000W
	9 pieces in serial and 2 sets in parallel	18 pcs	4500W
	10 pieces in serial and 2 sets in parallel	20 pcs	5000W
	11 pieces in serial and 2 sets in parallel (only for 6KVA model)	22 pcs	5500W
	12 pieces in serial and 2 sets in parallel (only for 6KVA model)	24 pcs	6000W

Take the 500Wp PV module as an example. After considering above two parameters, the recommended module configurations are listed in the table below.

Solar Panel Spec. (reference) - 500Wp Vmp: 38.0Vdc Imp: 13.0 A Voc: 40.0Vdc Isc: 14.0A	SOLAR INPUT		Q'ty of panels	Total input power
	Min. in serial: 2 pcs , max. in serial: 11 pcs			
	2 pcs in serial		2 pcs	1000W
	4 pcs in serial		4 pcs	2000W
	6 pcs in serial		6 pcs	3000W
	8 pcs in serial		8 pcs	4000W
	10 pcs in serial		10 pcs	5000W
	11 pcs in serial (only for 6KVA model)		11pcs	5500W
	6 pieces in serial and 2 sets in parallel (only for 6KVA model)		12 pcs	6000W

### PV Module Wire Connection

Please take the following to implement PV module connection:

1.Remove insulation sleeve for about 10 mm on your positive and negative wires.

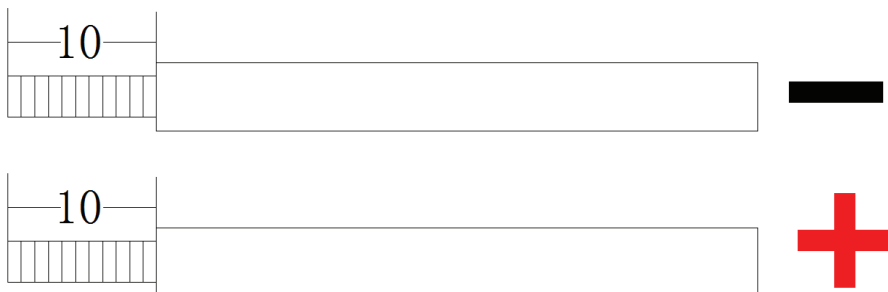

2.Check polarities of wire connections from PV modules to PV input screw terminals. Connect your wires as illustrated below.

Recommended tool: M4mm blade screwdriver

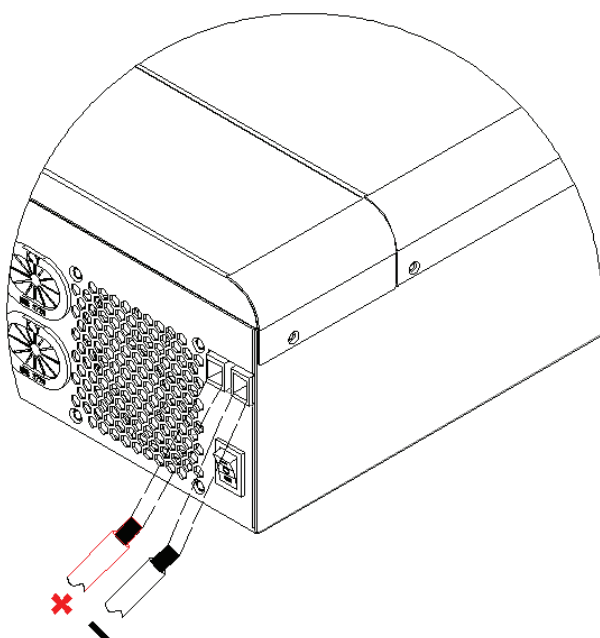

## 4.7 Dry Contact Signal

There is one dry contact (3A/250VAC) available on the rear panel. It could be used to deliver signal to external device when battery voltage reaches warning level.

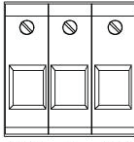
Unit Status	Condition	 NC C NO	
		NC & C	C & NO
Power Off	Unit is off and no output is powered	Open	Close
Power On	Battery voltage <Setting the voltage in program 12	Close	Open
	Battery voltage >Setting the voltage in program 13	Open	Close

## 4.8 Wi-Fi Connection(Optional)

- 1.The device has its own standard WIFI port, if users need to monitor the status and information of the device through WIFI, they must connect to the WIFI collector.
- 2.Users can download "SmartEss" WIFI monitoring software from the app store on their phone.
- 3.Inverters come equipped with factory-integrated Wi-Fi capability which makes it very easy to integrate into a home network (Wi-Fi Dongle is Optional)This makes it ideal for local monitoring via the inverter's own wireless home network or for online monitoring platforms.

## 4.9 Bluetooth Communication (Optional)

This unit is equipped with a Bluetooth transmitter. download "RevoMonitor" APP from Google Play . Once the APP is download, you may connect "RevoMonitor" APP to your inverter with the pairing password "1234". The communication distance is roughly 6 ~ 7 meters.

Note:1. the following data are for reference only.

2. Bluetooth APP only supports Android phone users.

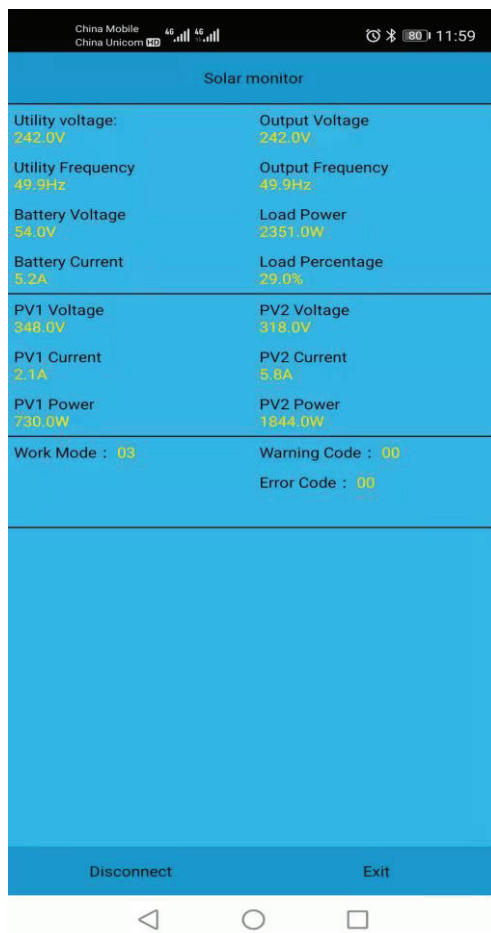

Solar monitor	
Utility voltage: 242.0V	Output Voltage 242.0V
Utility Frequency 49.9Hz	Output Frequency 49.9Hz
Battery Voltage 54.0V	Load Power 2351.0W
Battery Current 5.2A	Load Percentage 29.0%
PV1 Voltage 348.0V	PV2 Voltage 318.0V
PV1 Current 2.1A	PV2 Current 5.8A
PV1 Power 730.0W	PV2 Power 1844.0W
Work Mode : 03	Warning Code : 00
	Error Code : 00
Disconnect	Exit

## 5. Operation

### 5.1 Operation and Display Panel

The operation and display panel, shown in below chart, is on the front panel of the inverter. It includes three indicators, four touchable function keys and a LCD display, indicating the operating status and input/output power information.

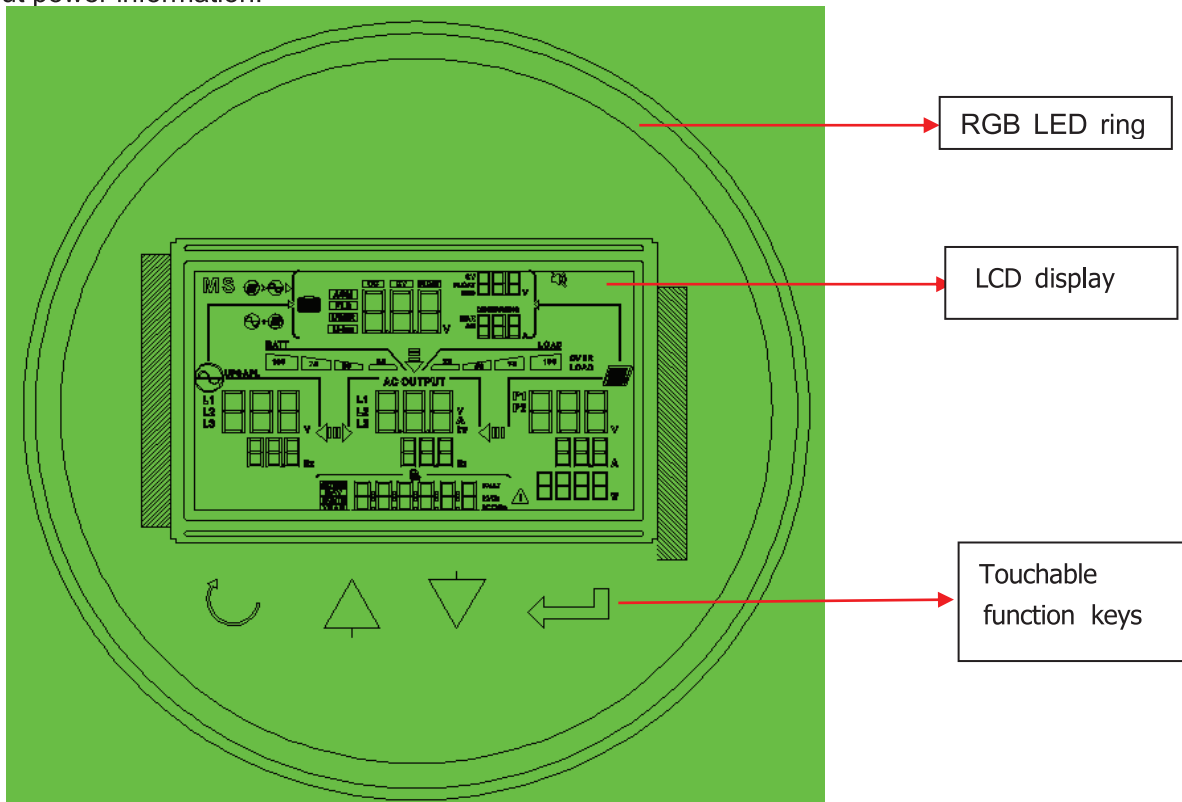

#### Touchable Function Keys

Function Key		Description
↻	ESC	To exit the setting
	Access USB setting mode	To enter USB setting mode
▲	Up	To last selection
▼	Down	To next selection
↵	Enter	To confirm/enter the selection in setting mode

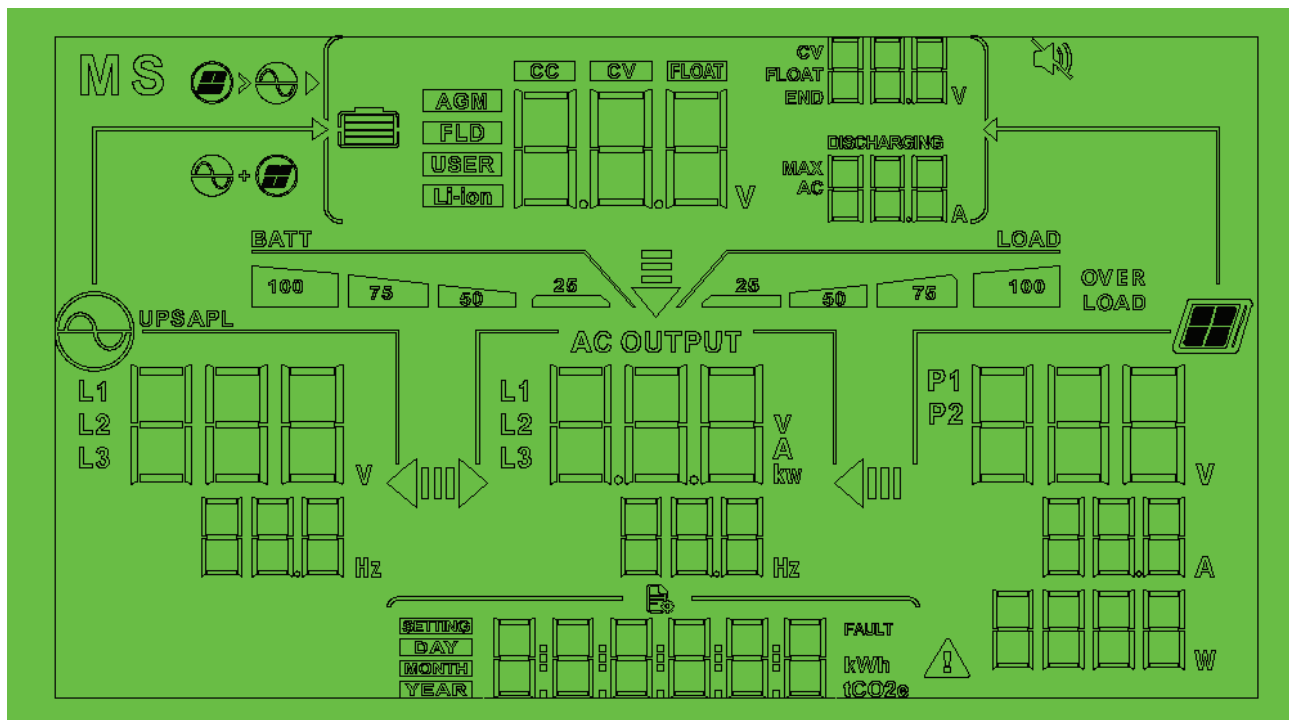

## 5.2 LCD Display Icons

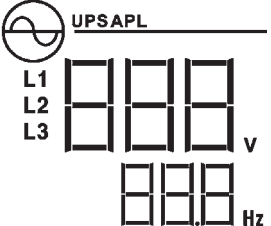
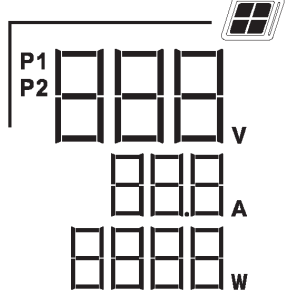
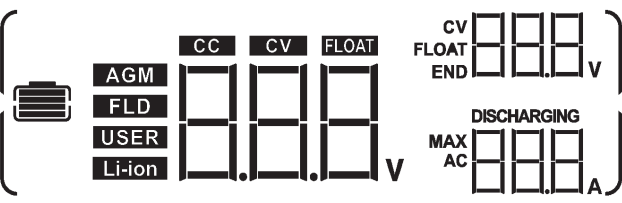

Icon	Function description
	Indicates the AC input voltage and frequency.
	Indicates the PV voltage, current and power.
	Indicates the battery voltage, charging stage, configured battery parameters, charging or discharging current.

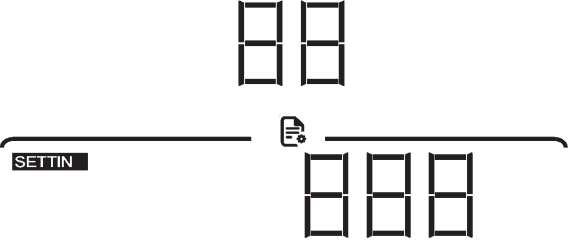
**Configuration Program and Fault Information**

	<p>Indicates the setting programs.</p>
---	--

	<p>Indicates the warning and fault codes. Warning: flashing with warning code</p>  <p>Fault: lighting with fault code.</p> 
---	---

**Output Information**

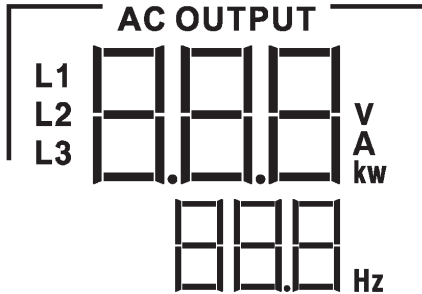



	<p>Indicate the output voltage, load in VA, and load in Watt and output frequency.</p>
--	--

**Battery Information**

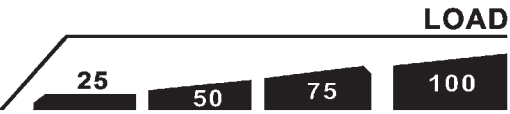

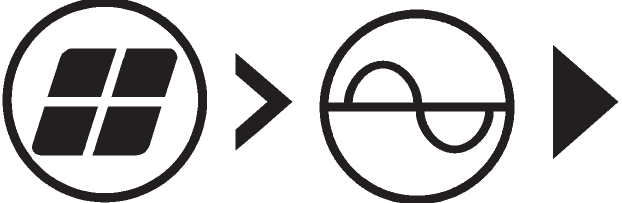
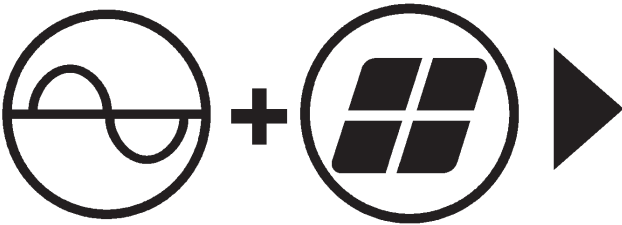
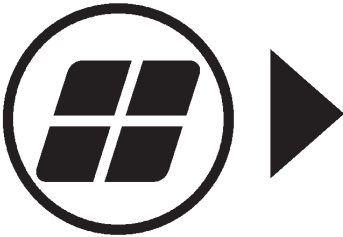

<p><b>BATT</b></p> 	<ol style="list-style-type: none"> <li>1.Indicates battery level by 1-25%, 26-49%, 51-75% and 76-100% in battery mode and charging status in line mode.</li> <li>2.When battery is charging, it will present battery charging status.</li> <li>3.Floating mode. Batteries are fully charged.4 bars will be on.</li> </ol>
--	---

**Load Information**

<p><b>OVER LOAD</b></p>	<p>Indicates overload.</p>
	<p>Indicates the load level by 0-25%, 26-50%, 51-75% and 76-100%.</p>

Charger Source Priority Setting Display	
	Indicates setting program 16 "Charger source priority" is selected as "Solar first".
	Indicates setting program 16 "Charger source priority" is selected as "Solar and Utility".
	Indicates setting program 16 "Charger source priority" is selected as "Solar only".
	Indicates setting program 01 "Output source priority" is selected as "Utility first".
	Indicates setting program 01 "Output source priority" is selected as "Solar first".
	Indicates setting program 01 "Output source priority" is selected as "SBU".
AC Input Voltage Range Setting Display	
<b>APL</b>	The acceptable AC input voltage range will be within 90-280VAC.
<b>UPS</b>	The acceptable AC input voltage range will be within 170-280VAC.
Operation Status Information	
	Indicates unit connects to the mains.





	<p>Indicates unit connects to the PV panel.</p>
<p><b>AGM</b></p> <p><b>FLD</b></p> <p><b>USER</b></p> <p><b>Li-ion</b></p>	<p>Indicates battery type.</p>
<p><b>DAY</b> </p>	<p>Date:Year,Month ,Day</p>
<p><b>DAY</b>  <b>kWh</b></p> <p><b>MONTH</b></p> <p><b>YEAR</b></p>	<p>Power generation</p>
	<p>Indicates unit alarm is disabled.</p>



### 5.3 LCD Setting

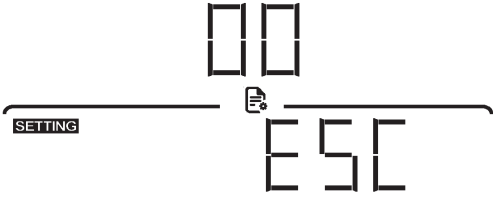

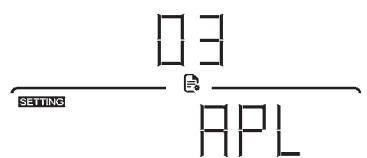
After pressing and holding “←” button for 3 seconds, the unit will enter the Setup Mode. Press “▲” or “▼” button to select setting programs. Press “←” button to confirm you selection or “↻” button to exit.

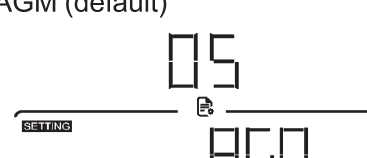
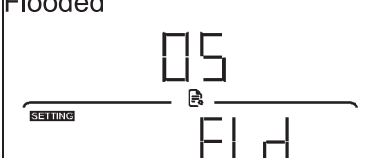
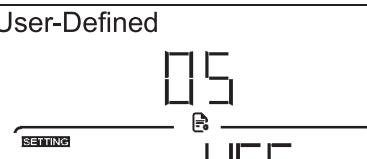
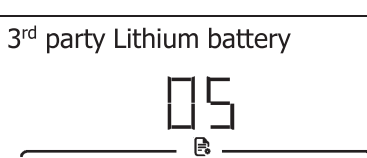
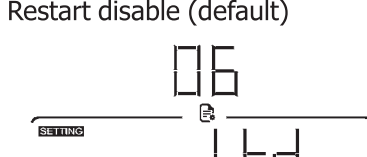
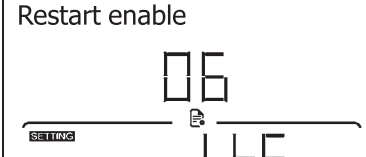
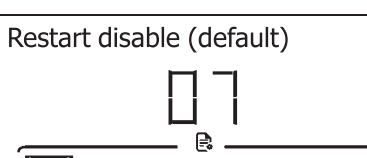
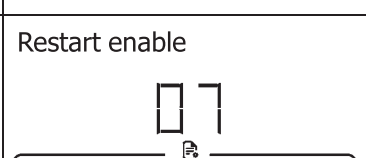
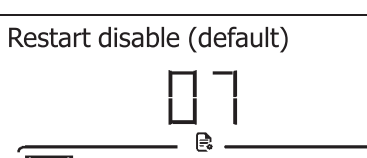
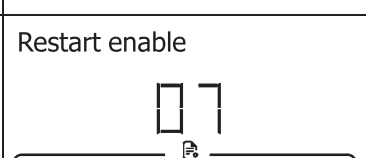
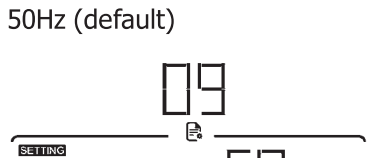
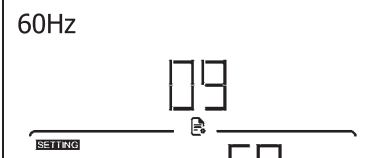

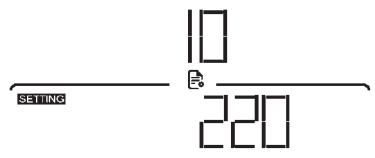

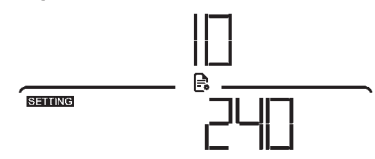
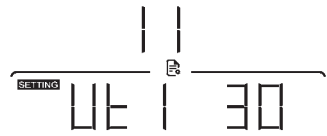
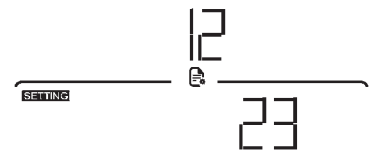
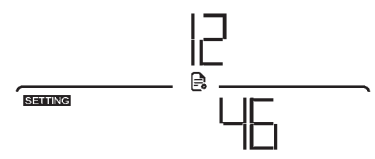
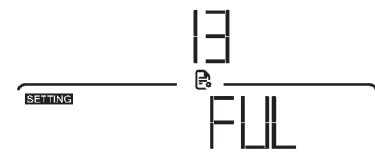
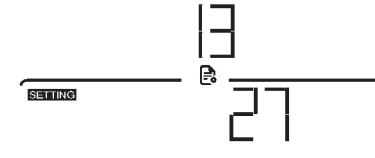
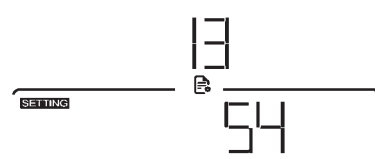
#### Setting Programs:

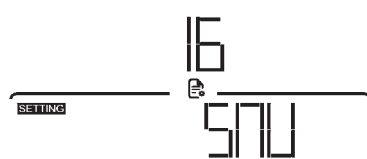
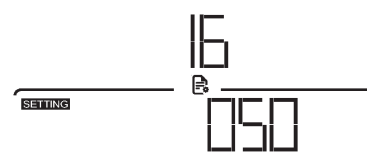
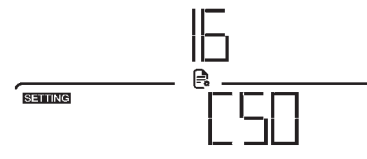
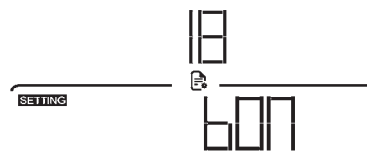
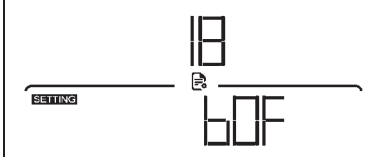
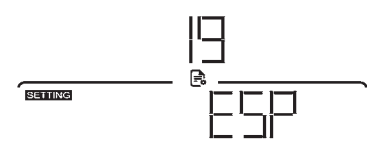
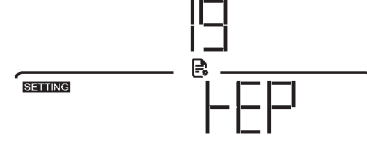

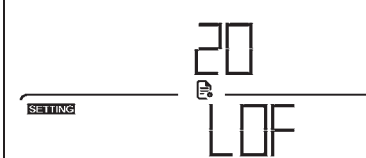
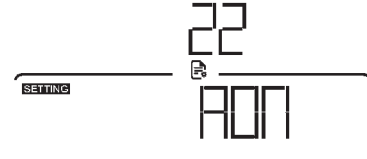
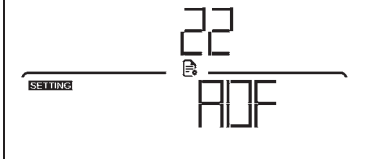

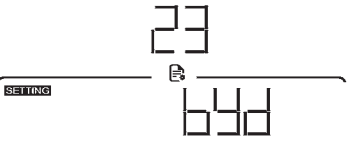
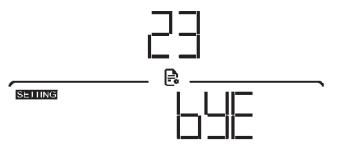
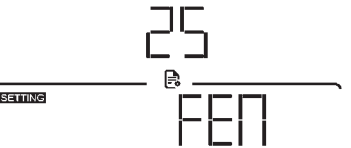
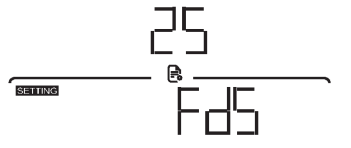
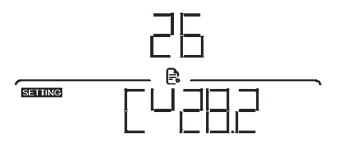
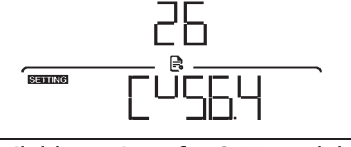
Program	Description	Selectable option	
00	Exit setting mode	Escape 	
01	Output source priority: To configure load power source priority	Utility first (default)	Utility will provide power to the loads as first priority. Solar and battery energy will provide power to the loads only when utility power is not available.
		Solar first	Solar energy provides power to the loads as first priority. If solar energy is not sufficient to power all connected loads, Utility energy will supply power to the loads at the same time.
		SBU priority	Solar energy provides power to the loads as first priority. If solar energy is not sufficient to power all connected loads, battery energy will supply power to the loads at the same time. Utility provides power to the loads only when battery voltage drops to either low- level warning voltage or the setting point in program 12.
02	Maximum charging current: To configure total charging current for solar and utility chargers. (Max. charging current = utility charging current + solar charging current)	60A (default)	Setting range is from 10A to 120A. Increment of each click is 10A.

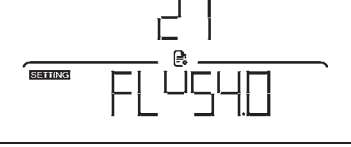
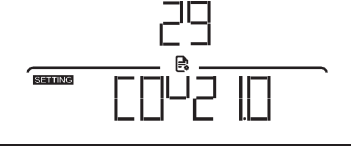

03	AC input voltage range	Appliances (default) 	If selected, acceptable AC input voltage range will be within 90-280VAC.
		UPS 	If selected, acceptable AC input voltage range will be within 170-280VAC.
05	Battery type	AGM (default) 	Flooded 
		User-Defined 	If "User-Defined" is selected, battery charge voltage and low DC cut-off voltage can be set up in program 26, 27 and 29.
		3 <sup>rd</sup> party Lithium battery 	If selected, programs of 02, 26, 27 and 29 will be automatically set up. No need for further setting. Please contact the battery supplier for installation procedure. <b>Note:</b> if you have a lithium battery, you can choose this option. When you plug in BMS communications, screen will show "LIC".
06	Auto restart when overload occurs	Restart disable (default) 	Restart enable 
		Restart disable (default) 	Restart enable 
07	Auto restart when over temperature occurs	Restart disable (default) 	Restart enable 
09	Output frequency	50Hz (default) 	60Hz 

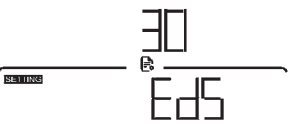
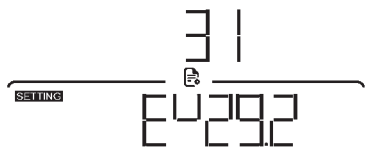
10	Output voltage	220V 	230V (default) 
		240V 	
11	Maximum utility charging current Note: If setting value in program 02 is smaller than that in program in 11, the inverter will apply charging current from program 02 for	30A (default) 	Setting range is 2A, then from 10A to 100A. Increment of each click is 10A.
12	Setting voltage point back to utility source when selecting "SBU" (SBU priority) in program 01.program 01.	Available options for 24V model:	
		23V (default) 	Setting range is from 22V to 25V. Increment of each click is 1V.
	Available options for 48V model:		
	Second output	46V (default) 	Setting range is from 44V to 51V. Increment of each click is 1V.
13	Setting voltage point back to battery mode when selecting "SBU" (SBU priority) in program 01.	Battery fully charged 	
		Available options for 24V model:	27V (default)from Setting range is from 24V to 29V. Increment of each click is 1V.
		Available options for 48V model:	54V (default) Setting range is from 48V to 58V. Increment of each click is 1V.
			
			

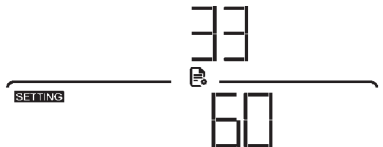
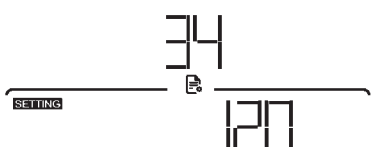
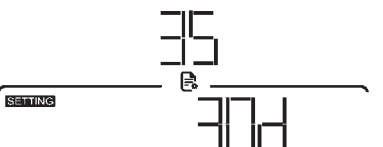

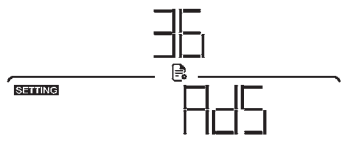

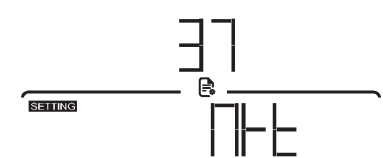
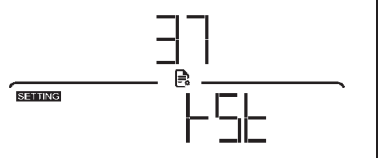
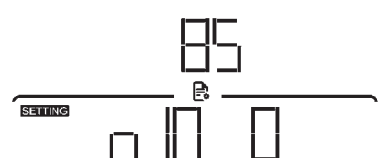
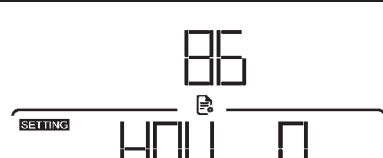
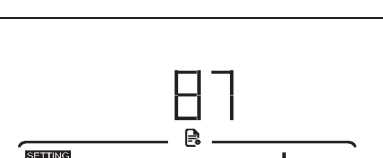
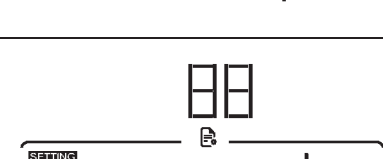
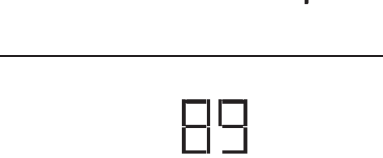
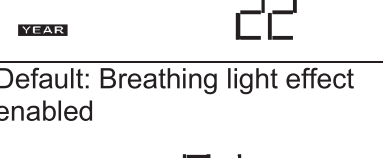
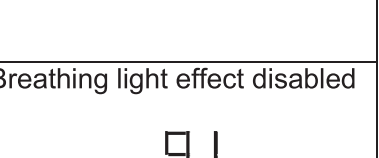
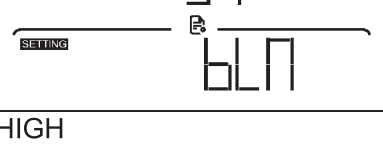
16	Charger source priority: To configure charger source priority	If this inverter/charger is working in Line, Standby or Fault mode, charger source can be programmed as below:	
		Solar and Utility (default) 	Solar energy and utility will charge battery at the same time.
		Only Solar 	Solar energy will be the only charger source no matter utility is available or not.
		Solar first 	Solar energy will charge battery as first priority. Utility will charge battery only when solar energy is not available.
18	Alarm control	Alarm on (default) 	Alarm off 
19	Auto return to default display screen	Return to default display screen (default) 	If selected, no matter how users switch display screen, it will automatically return to default display screen after no button is pressed for 1 minute.
		Stay at latest screen 	If selected, the display screen will stay at latest screen user finally switches.
20	Backlight control	Backlight control 	Backlight off 
22	Beeps while primary Source is interrupted	Alarm on (default) 	Alarm off 

23	Overload bypass: When enabled, the unit will transfer to line mode if overload occurs in battery mode.	Bypass disable (default) 	Bypass enable 
25	Record Fault code	Record enable (default) 	Record disable 
26	Bulk charging voltage (C.V voltage)	Available options for 24V model: 28.2V (default) 	If user-defined is selected in program 5, this program can be set up. Setting range is from 24.0V to 30.5V. Increment of each click is 0.1V.
		Available options for 48V model: 56.4V (default) 	If user-defined is selected in program 5, this program can be set up. Setting range is from 48.0V to 61.0V. Increment of each click is 0.1V.
27	Floating charging voltage	Available options for 24V model: 27.0V (default) 	If user-defined is selected in program 5, this program can be set up. Setting range is from 24.0V to 30.5V. Increment of each click is 0.1V.
		Available options for 48V model: 54.0V (default) 	If user-defined is selected in program 5, this program can be set up. Setting range is from 48.0V to 61.0V. Increment of each click is 0.1V.
29	Low DC cut-off voltage: 1.If battery power is only power source available, inverter will shut down. 2.If PV energy and battery power are available, inverter will charge battery without	Available options for 24V model: 21.0V (default) 	If user-defined is selected in program 5, this program can be set up. Setting range is from 21.0V to 24.0V. Increment of each click is 0.1V. Low DC cut-off voltage will be fixed to setting value no matter what
29	Low DC cut-off voltage: 1.If battery power is only power source available, inverter will shut down. 2.If PV energy and battery power are available, inverter will charge battery without	Available options for 48V model: 42.0V (default) 	If user-defined is selected in program 5, this program can be set up. Setting range is from 42.0V to 48.0V. Increment of each click is 0.1V. Low DC cut-off voltage will be fixed to setting value no matter what
30	Battery equalization	Battery equalization enable	Battery equalization disable (default)

			
		<p><b>Note:</b> If "Flooded" or "User-Defined" is selected in program 05, this program can be set up.</p>	
31	Battery equalization voltage	<p>Available options for 24V model: 29.2V (default)</p> 	<p>Setting range is from 24.0V to 30.5V. Increment of each click is 0.1V.</p>
		<p>58.4V (default)</p> 	<p>Setting range is from 48.0V to 61.0V. Increment of each click is 0.1V.</p>
33	Battery equalized time	<p>60min (default)</p> 	<p>Setting range is from 5min to 900min. Increment of each click is 5min.</p>
		<p>120min (default)</p> 	<p>Setting range is from 5min to 900 min. Increment of each click is 5 min.</p>
34	Battery equalized timeout	<p>30days (default)</p> 	<p>Setting range is from 0 to 90 days. Increment of each click is 1 day.</p>
35	Equalization interval	<p>Enable</p> 	<p>Disable (default)</p> 
36	Equalization activated immediately	<p>If equalization function is enabled in program 30, this program can be set up. If "Enable" is selected in this program, it's to activate battery equalization immediately and LCD main page will show "E9". If "Disable" is selected, it will cancel equalization function until next activated equalization time arrives based on program 35 setting. At this time, "E9" will not be shown in LCD main page.</p>	

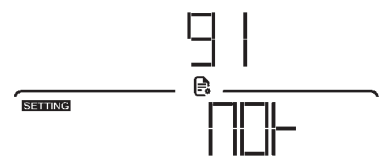
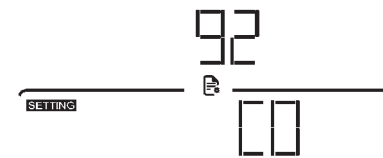
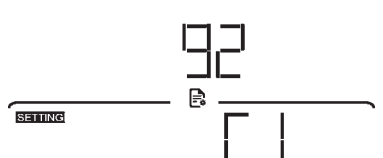
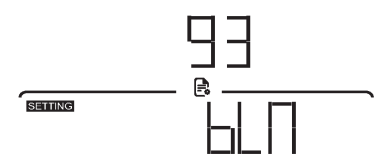
37	Reset all stored data for PV generated power and output load energy	Not reset(Default) 	Reset 
85	Time setting – Minute		For minute setting, the range is from 0 to 59.
86	Time setting – Hour		For hour setting, the range is from 0 to 23.
87	Time setting– Day		For day setting, the range is from 1 to 31.
88	Time setting– Month		For month setting, the range is from 1 to 12.
89	Time setting – Year		For year setting, the range is from 17 to 99.
91	Surround RGB brightness	Default: Breathing light effect enabled 	Breathing light effect disabled 
		HIGH 	Brightness of RGB LED:LOW 

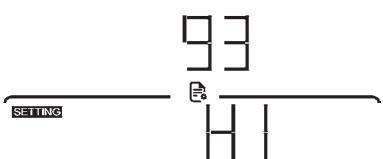
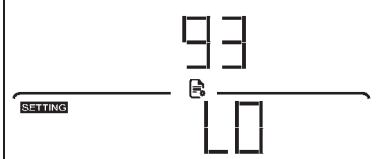
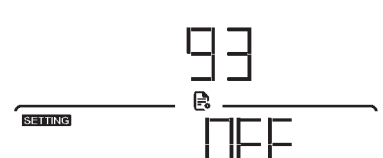
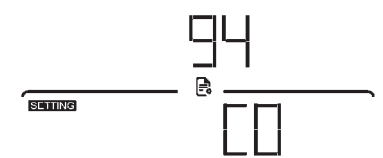

		Brightness of RGB LED: NORMAL 	
92	Surrounding the RGB LED lighting color	LOW Default: 	The cycle of seven kinds of color.
		LOW 	" [ 1 " to " [ 7 " can be used in one of the colors
93	The Logo of brightness of RGB LED	Default: enabled 	disabled 
		HIGH 	LOW 
		NORMAL 	
94	The Logo color of RGB LED		The cycle of seven kinds of color.
			" [ 1 " to " [ 7 " can be used in one of the colors

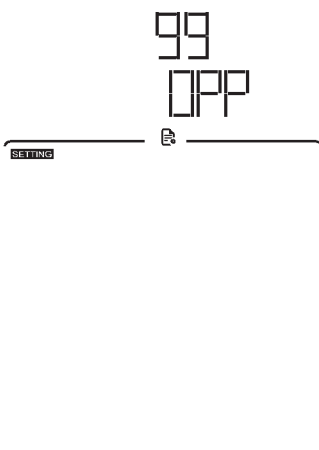
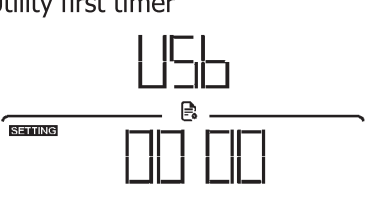
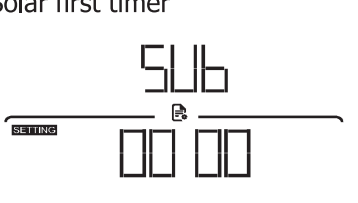
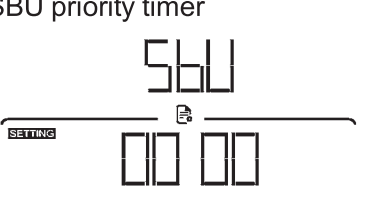
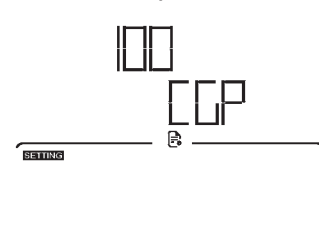
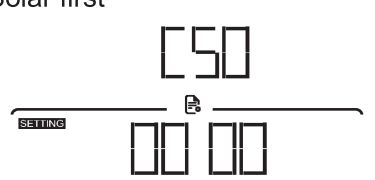
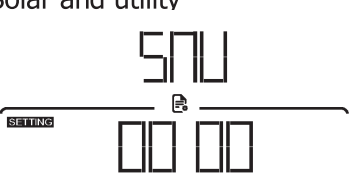
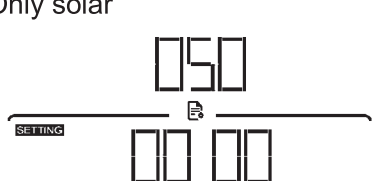
<p>99</p>	<p>Timer Setting for Output Source Priority</p> 	<p>Once access this program, it will show “OPP” in LCD. Press “←” button to select timer setting for output source priority. There are three timers to set up. Press “▲” or “▼” button to select specific timer option. Then, press “←” to confirm timer option. Press “▲” or “▼” button to adjust starting time first and the setting range is from 00 to 23. Increment of each click is one hour. Press “←” to confirm starting time setting. Next, the cursor will jump to right column to set up end time. Once end time is set completely, press“←” to confirm all setting.</p>	
		<p>Utility first timer</p> 	<p>Solar first timer</p> 
		<p>SBU priority timer</p> 	
<p>100</p>	<p>Timer Setting for Charger Source Priority</p> 	<p>Once access this program, it will show “CGP” in LCD. Press “←” button to select timer setting for charger source priority. There are three timers to set up. Press “▲” or “▼” button to select specific timer option. Then, press “←” to confirm timer option. Press “▲” or “▼” button to adjust starting time first and the setting range is from 00 to 23. Increment of each click is one hour. Press “←” to confirm starting time setting. Next, the cursor will jump to right column to set up end time. Once end time is set completely, press“←” to confirm all setting.</p>	
		<p>Solar first</p> 	<p>Solar and utility</p> 
		<p>Only solar</p> 	

## 5.4 Battery Equalization Description

Battery equalization function is built into the charge controller. It reverses the buildup of negative chemical effects such as stratification, a condition where acid concentration is greater at the bottom of the battery than at the top. Equalization also helps to remove sulfate crystals that may have built up on the plates. If left unchecked, this condition, called sulfating, will reduce the overall capacity of the battery. Therefore, it's recommended to equalize the battery periodically.

How to Activate Equalization Function

You must enable battery equalization function in LCD setting Program 30 first. Then you can apply this function by either one of the following methods.

1. Setting equalization interval in Program 35.
2. Activate equalization immediately in Program 36.

When to Equalize

In floating charge stage, when setting the equalization interval (battery equalization cycle) is reached, or equalization is activated immediately, the controller will start to enter Equalize Mode.

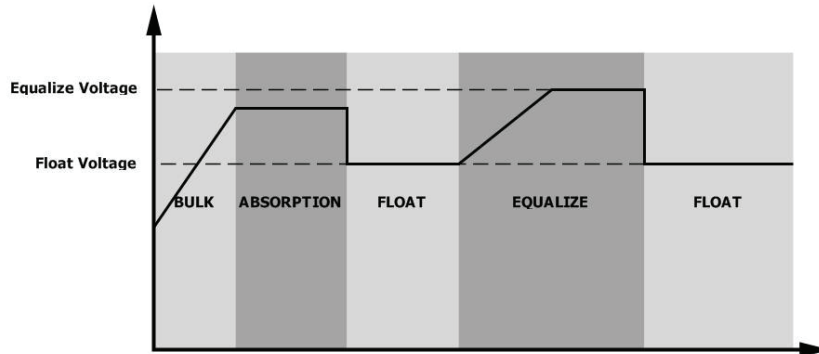

Equalize Charging and Timeout

In Equalize Mode, the controller will supply power to charge battery as much as possible until battery voltage reach the equalization voltage. Then, constant-voltage regulation is applied to maintain battery voltage at the equalization level. The battery will remain in the Equalize Mode until the equalization timer runs out.

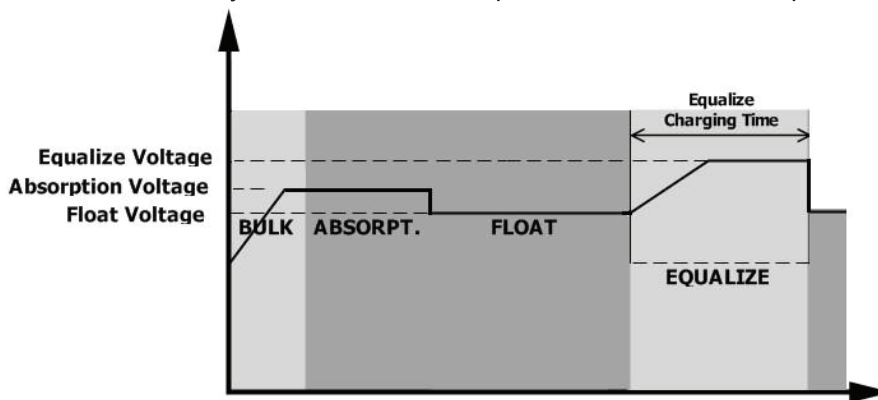

However, in Equalize Mode, if the battery equalization timer runs out and the battery voltage doesn't recover to the battery equalization voltage point, the charge controller will extend the battery equalized time until battery voltage to equalization voltage. If the battery voltage is still lower than equalization voltage when the extension runs out, the charge controller will stop equalization and return to the floating charging stage.

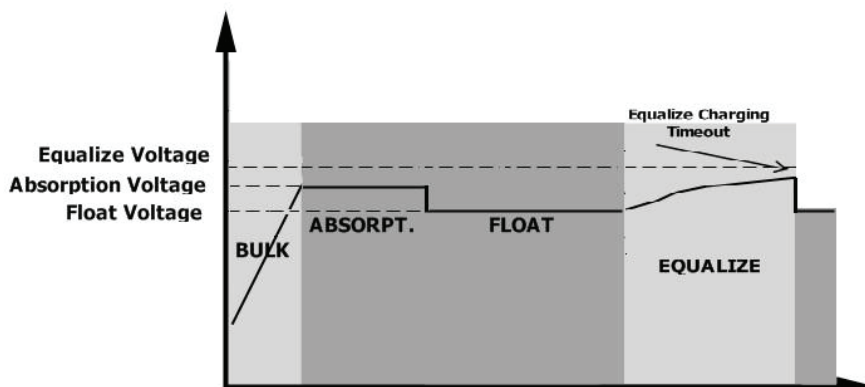

## 5.5 Fault Reference Code

Fault Code	Fault Event
01	Fan is locked when inverter is off
02	Over temperature
03	Battery voltage is too high
04	Battery voltage is too low
05	Output short circuited or over temperature is detected by internal converter components
06	Output voltage is too high
07	Overload time out
08	Bus voltage is too high
09	Bus soft start failed
51	Over current or surge
52	Bus voltage is too low
53	Inverter soft start failed
55	Over DC voltage in AC output
57	Current sensor failed
58	Output voltage is too low
59	PV voltage is over limitation

## 5.6 Warning Indicator

Warning Code	Warning Event
01	Fan is locked when inverter is on.
02	Over temperature
03	Battery is over-charged
04	Low battery
07	Overload
10	Output power derating
15	PV energy is low.
16	High AC input (>280VAC) during BUS soft start
32	Communication failure between inverter and display panel
£9	Battery equalization
6P	Battery is not connected

## 6. Specifications

**Table 1 Line Mode Specifications**

INVERTER MODEL	EM-4024TW S1 ULTRA	EM-6048TW S1 ULTRA
Input Voltage Waveform	Sinusoidal (utility or generator)	
Nominal Input Voltage	230Vac	
Low Loss Voltage	170Vac±7V (narrow range); 90Vac±7V (wide range)	
Low Loss Return Voltage	180Vac±7V (narrow range); 100Vac±7V (wide range)	
High Loss Voltage	280Vac±7V	
High Loss Return Voltage	270Vac±7V	
Max AC Input Voltage	300Vac	
Nominal Input Frequency	50Hz / 60Hz (Auto detection)	
Low Loss Frequency	40±1Hz	
Low Loss Return Frequency	42±1Hz	
High Loss Frequency	65±1Hz	
High Loss Return Frequency	63±1Hz	
Output Short Circuit Protection	Circuit Breaker	
Efficiency (Line Mode)	>95% ( Rated R load, battery full charged )	
Transfer Time	10ms typical (wide range ); 20ms typical (narrow range)	
Output power derating: When AC input voltage drops to 170V, the output power will be derated.		

## Table 2 Inverter Mode Specifications

INVERTER MODEL	EM-4024TW S1 ULTRA	EM-6048TW S1 ULTRA
Rated Output Power	4000W	6000W
Output Voltage Waveform	Pure Sine Wave	
Output Voltage Regulation	230Vac±5%	
Output Frequency	50Hz	
Peak Efficiency	93%	
Overload Protection	5s@≥130% load; 10s@105%~130% load	
Surge Capacity	2* rated power for 5 seconds	
Nominal DC Input Voltage	24Vdc	48Vdc
Cold Start Voltage	23.0Vdc	46.0Vdc
Low DC Warning Voltage @ load < 50%	23.0Vdc	46.0Vdc
@ load ≥ 50%	22.0Vdc	44.0Vdc
Low DC Warning Return Voltage @ load < 50%	23.5Vdc	47.0Vdc
@ load ≥ 50%	23.0Vdc	46.0Vdc
Low DC Cut-off Voltage @ load < 50%	21.5Vdc	43.0Vdc
@ load ≥ 50%	21.0Vdc	42.0Vdc
High DC Recovery Voltage	32Vdc	62Vdc
High DC Cut-off Voltage	33Vdc	63Vdc
No Load Power Consumption	<35W	<50W

### Table 3 Charge Mode Specifications

Utility Charging Mode		
INVERTER MODEL	EM-4024TW S1 ULTRA	EM-6048TW S1 ULTRA
Charging Algorithm	3-Step	
AC Charging Current (Max)	100A(@VI/P=230Vac)	
Bulk Charging Voltage	Flooded Battery	29.2Vdc
	AGM / Gel Battery	28.2Vdc
Floating Charging Voltage	27Vdc	54Vdc
Charging Curve		
	<p>MPPT Solar Charging Mode</p>	
INVERTER MODEL	EM-4024TW S1 ULTRA	EM-6048TW S1 ULTRA
Max. PV Array Power	5000W	6000W
Nominal PV Voltage	320Vdc	360Vdc
Start-up Voltage	70Vdc +/- 10Vdc	
PV Array MPPT Voltage Range	60-450Vdc	
MAX. PV Input Current	27A	
Max. PV Array Open Circuit Voltage	500Vdc	
Max Charging Current (AC charger + solar charger)	120A	

### Table 4 General Specifications

INVERTER MODEL	EM-4024TW S1 ULTRA	EM-6048TW S1 ULTRA
Operating Temperature Range	-10°C ~ 50°C	
Storage temperature	-15°C ~ 60°C	
Humidity	5% to 95% Relative Humidity (Non-condensing)	
Dimension (D*W*H), mm	127*313*466	
Net Weight, kg	9	10

## 7. Trouble Shooting

Problem	LCD/LED/Buzzer	Explanation / Possible cause	What to do
Unit shuts down automatically during startup process.	LCD/LEDs and buzzer will be active for 3 seconds and then complete off.	The battery voltage is too low (<1.91V/Cell)	1. Re-charge battery. 2. Replace battery.
No response after power on.	No indication.	1. The battery voltage is far too low. (<1.4V/Cell) 2. Internal fuse tripped.	1. Contact repair center for replacing the fuse. 2. Re-charge battery. 3. Replace battery.
Mains exist but the unit works in battery mode.	Input voltage is displayed as 0 on the LCD and green LED is flashing.	Input protector is tripped	Check if AC breaker is tripped and AC wiring is connected well.
	Green LED is flashing.	Insufficient quality of AC power. (Shore or Generator)	1. Check if AC wires are too thin and/or too long. 2. Check if generator (if applied) is working well or if input voltage range setting is correct.
	Green LED is flashing.	Set "SUB" (solar first) as the priority of output source.	Change output source priority to "USB" (utility first).
When the unit is turned on, internal relay is switched on and off repeatedly.	LCD display and LEDs are flashing	Battery is disconnected.	Check if battery wires are connected well.
Buzzer beeps continuously and red LED is on.	Fault code 07	Overload error. The inverter is overload 110% and time is up.	Reduce the connected load by switching off some equipment.
		If PV input voltage is higher than specification, the output power will be derated. At this time, if connected loads is higher than derated output power, it will cause overload.	Reduce the number of PV modules in series or the connected load.
	Fault code 05	Output short circuited.	Check if wiring is connected well and remove abnormal load.
		Temperature of internal converter component is over 120°C.	Check whether the air flow of the unit is blocked or whether the ambient temperature is too high.
Fault code 02	Internal temperature of inverter component is over 100°C.		



Buzzer beeps continuously and red LED is on.	Fault code 03	Battery is over-charged.	Return to repair center.
		The battery voltage is too high.	Check if spec and quantity of batteries are meet requirements.
	Fault code 01	Fan fault	Replace the fan.
	Fault code 06/58	Output abnormal (Inverter voltage below than 190Vac or is higher than 260Vac)	1. Reduce the connected load. 2. Return to repair center
	Fault code 08/09/53/57	Internal components failed.	Return to repair center.
	Fault code 51	Over current or surge.	Restart the unit, if the error happens again, please return to repair center.
	Fault code 52	Bus voltage is too low.	
	Fault code 55	Output voltage is unbalanced.	
Fault code 59	PV input voltage is beyond the specification.	Reduce the number of PV modules in series.	

## 8. Installation Dimension Drawing

**NOTE:** The following picture is only a schematic diagram of the equipment .If the actual chassis does not conform to the schematic due to a structural upgrade , it is subject to prior notice.

Unit: mm

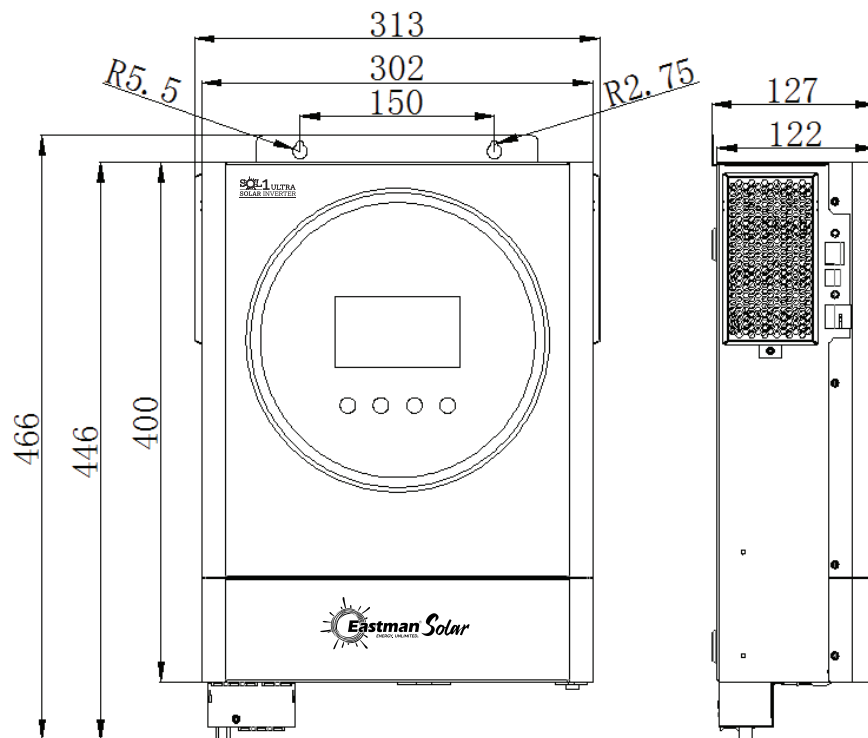



**AMPS MIDDLE EAST FZ LLC**  
#703, 7<sup>TH</sup> Floor, Deira Twin Tower,  
Baniyas Square, Deira, Dubai (UAE)

**EASTMAN AUTO & POWER LTD.**  
ASF Towers, 249, Udyog Vihar Phase-4,  
Gurugram, Haryana-122016, India

**GUANGDONG EASTMAN NEW ENERGY CO., LTD**  
#1602, Meilan business centre, Intersection of Xixiang Avenue  
and Qianjin Second Road, Bao'an, District, Shenzhen-518102, China